



Direct-acting 3/2-way plunger valve

- Direct-acting and compact small valve up to DN 1.6
- Slipped over coil system
- Banjo fitting for direct mounting on pneumatic valves
- Simple and fast push-in, flange or manifold mounting



Product variants described in the data sheet may differ from the product presentation and description.

Type description

The 7012 valve is a direct-acting plunger valve. The stopper and the core guide tube are welded together to enhance pressure resistance and leak-tightness. Various body and seal material combinations are available depending on the actual application. A Bürkert-specific flange variant (SFB) enables the space-saving arrangement of valves on a multiple manifold. Push-in fittings can be selected for a flexible hose connection. A banjo connection with banjo bolt is the ideal solution for easy direct mounting on a pneumatic actuator. Optional manual override enables quick start-up and optimal maintenance. In combination with a plug to industry standard Form B or DIN EN 17301-803 Form C, the valves satisfy degree of protection IP65.

Table of contents

1. General technical data	3
2. Circuit functions	4
3. Materials	4
3.1. Chemical Resistance Chart – Bürkert resistApp.....	4
3.2. Material specifications	4
Standard version.....	4
Banjo version	5
4. Dimensions	6
4.1. Standard version.....	6
Versions according to industry standard Form B	6
PIN Assignments	6
Versions according to industry standard Form B	7
Further electrical connections.....	7
4.2. Banjo version	8
Versions according to industry standard Form B, coil size 24.5 mm.....	8
4.3. Multiple manifold	8
5. Performance specifications	9
5.1. Power consumption of standard coil version 24.5 mm	9
5.2. Power consumption of standard coil version 20 mm	9
6. Ordering information	10
6.1. Bürkert eShop – Easy ordering and quick delivery.....	10
6.2. Bürkert product filter.....	10
6.3. Ordering chart.....	11
Standard version according to industry standard Form B, coil size 24.5 mm.....	11
Standard version according to industry standard Form B, coil size 20 mm.....	12
Banjo version, coil size 24.5 mm	13
Additional options.....	14
6.4. Ordering chart accessories.....	14
Accessories for manifolds	14
Cable plug Type 2516 acc. to DIN EN 175301 - 803 Form C	15
Cable plug Type 2507 acc. to industry standard Form B	15

1. General technical data

Product properties	
Dimensions	Detailed information can be found in chapter "4. Dimensions" on page 6.
Material	
Body	Brass, polyamide (PA), stainless steel 1.4305
Seal	FKM, EPDM
Weight	
Standard version 24.5 mm solenoid coil	146 g (with G 1/8)
Standard version 20 mm solenoid coil	120 g (with G 1/8)
Banjo version	135 g
Circuit function	Detailed information can be found in chapter "2. Circuit functions" on page 4.
Thermal insulation class of solenoid	Epoxy: class H
Manual override	Optional, standard for Type 7012 banjo version
Performance data	
Nominal operating mode	
Single valve	Continuous operation 100 % ED resp. 50 % ED
For block mounting on multiple manifold	With 4 W/5 W solenoid coil 100 % ED (at max. 55 °C)
Switching times ¹⁾	
Standard version	Orifice 1.2...1.6 mm: opening 8...12 ms, closing 8...12 ms
Banjo version	Orifice 1.2 mm: opening 7...12 ms, closing 7...12 ms
Circuit function	C and D
Electrical data	
Operating voltage	24 V DC, 24 V / 50 Hz, 110 / 230 V / 50 Hz
Voltage tolerance	± 10 %
Medium data	
Viscosity (max.)	21 mm ² /s
Operating medium	Neutral gases and fluids (e.g. compressed air, water, hydraulic oil, technical vacuum)
Medium temperature	
Standard version	- 10 °C...+ 100 °C
Banjo version	- 10 °C...+ 60 °C
Process/Port connection & communication	
Port connection	
Standard version	M5, G 1/8, Flange
Banjo version	G 1/8, G 1/4 and hose connector Ø 6 mm
Electrical connection	<ul style="list-style-type: none"> • Acc. to DIN EN 175301 - 803 Form C for cable plug Type 2516 • Acc. to industry standard Form B for cable plug Type 2507 • Flat pin terminal as protection class III device • Flying leads connection on request for coil size 20 mm
Approvals and Certificates	
Degree of protection	IP65 with cable plug
Environment and installation	
Installation position	As required, preferably with actuator upright
Ambient temperature	
Standard version	Max. +55 °C resp. 75 °C depending on power level
Banjo version	- 10 °C...+ 40 °C

1.) Measured at valve outlet at 6 bar and +20 °C according to ISO 12238, opening: pressure rise 0...10 %, closing: pressure drop 100...90 %

2. Circuit functions

Circuit functions	Description
	Type: C, solenoid valve 3/2 way Direct-acting Normally closed
	Type: D, solenoid valve 3/2 way Direct-acting Normally open

3. Materials

3.1. Chemical Resistance Chart – Bürkert resistApp

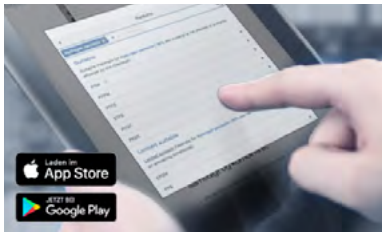

Bürkert resistApp – Chemical Resistance Chart

You want to ensure the reliability and durability of the materials in your individual application case? Verify your combination of media and materials on our website or in our resistApp.

Start Chemical Resistance Check

3.2. Material specifications

Standard version

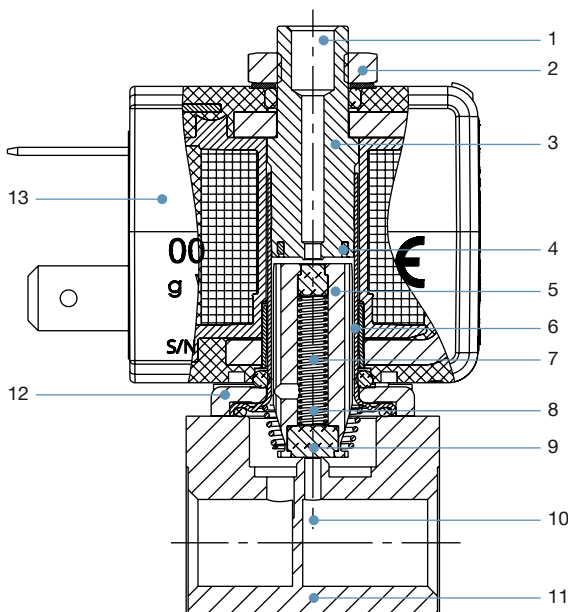

No.	Element	Material
1	Pressure port P	For circuit function D
2	Locknut	DIN 176 Surface finish thick film passivated KOSA0101
3	Stopper	Stainless steel 1.4113
4	Shading ring	Copper (silver optional)
5	Core	Stainless steel 1.4113
6	Guide tube	Stainless steel 1.4303
7	Spring	Stainless steel 1.4310
8	O-ring	FKM/EPDM
9	Seal	FKM/EPDM
10	Pressure port P	For circuit function C
11	Valve body	Brass, stainless steel 1.4305 PA (polyamide)
12	Flange	<ul style="list-style-type: none"> Surface finish thick film passivated KOSA0101 (brass version) Nickel-plated surface (stainless steel version)
13	Coil	Epoxy

Banjo version

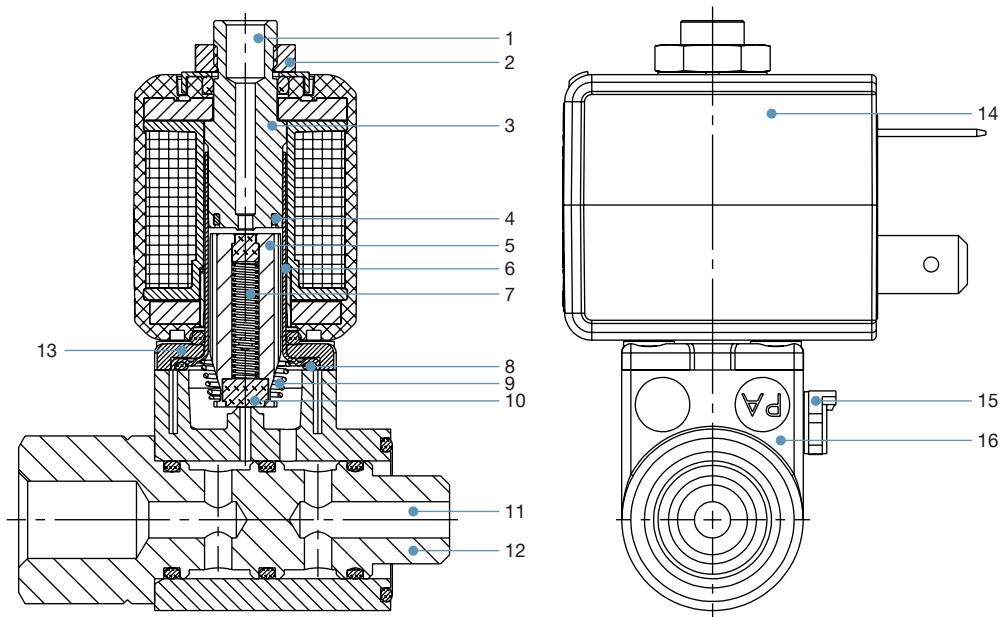

No.	Element	Material
1	Pressure port P	For circuit function D
2	Locknut	DIN 176 Surface finish thick film passivated KOSA0101
3	Stopper	Stainless steel 1.4113
4	Shading ring	Copper (silver optional)
5	Core	Stainless steel 1.4113
6	Guide tube	Stainless steel 1.4303 ST
7	Spring	Stainless steel 1.4310
8	O-ring	FKM
9	Spring	Stainless steel 1.4310
10	Seal	FKM
11	Pressure port P	For circuit function C
12	Banjo bolt	Nickel-plated brass
13	Flange	<ul style="list-style-type: none"> • Surface finish thick film passivated KOSA0101 (brass version) • Nickel-plated surface (stainless steel version)
14	Coil	Epoxy
15	Manual override	Durethan
16	Body	PA (polyamide)

DTS 1000446517 EN Version: B Status: RL (released | freigegeben | validé) printed: 28.01.2021

4. Dimensions

4.1. Standard version

Versions according to industry standard Form B

Note:

Dimensions in mm

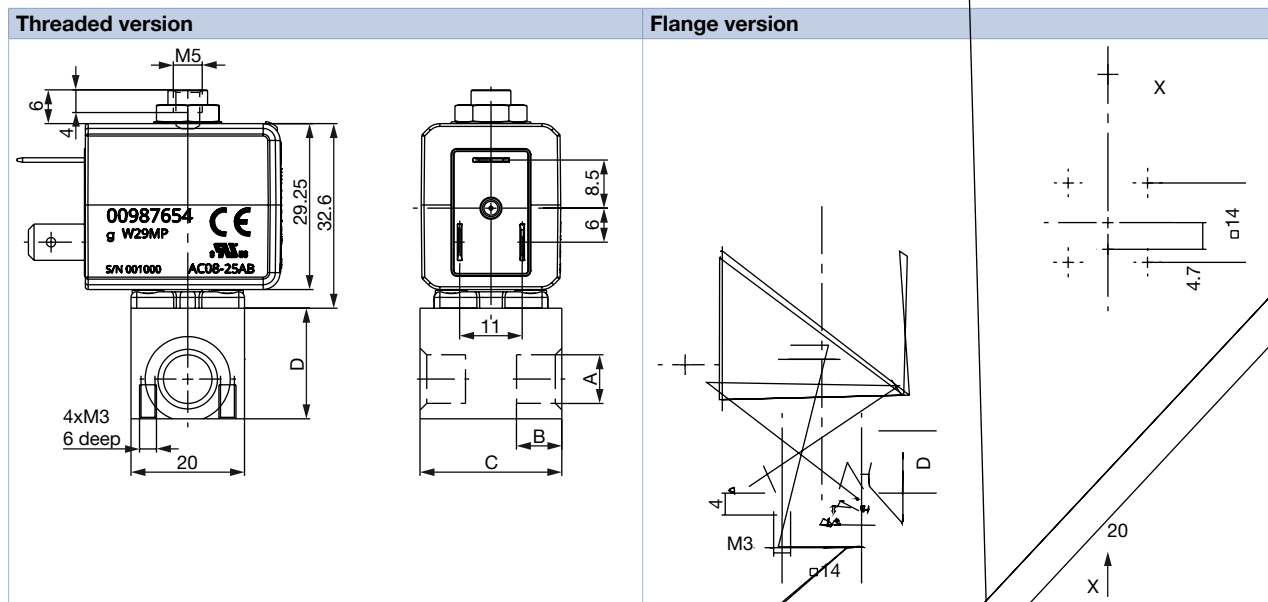

DTS 1000446517 EN Version: B Status: RL (released | freigegeben | valide) printed: 28.01.2021

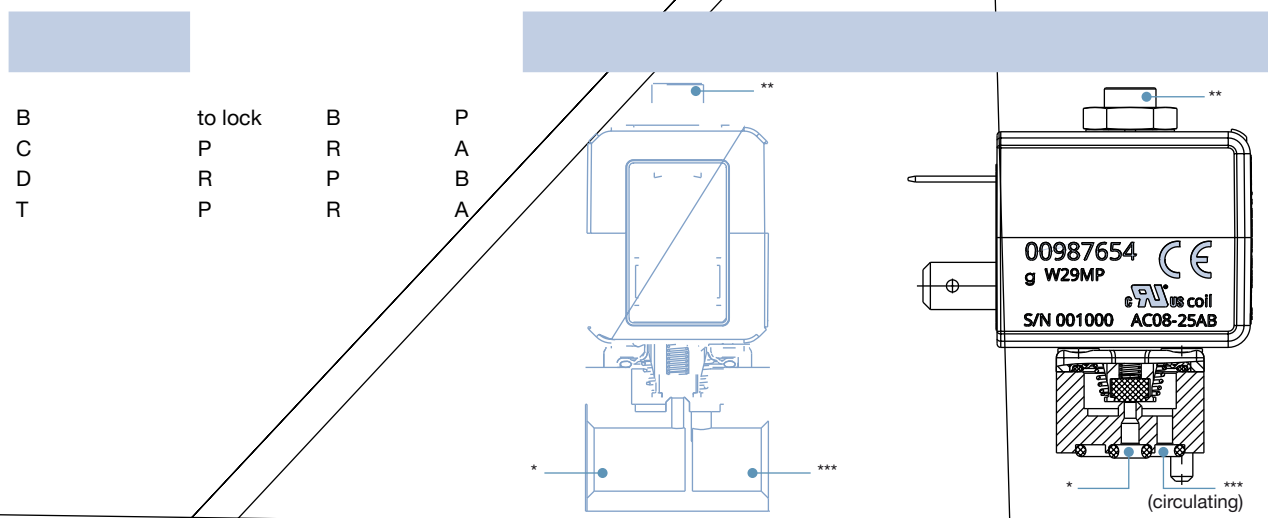

Versions according to industry standard Form B

Note:
Dimensions in mm

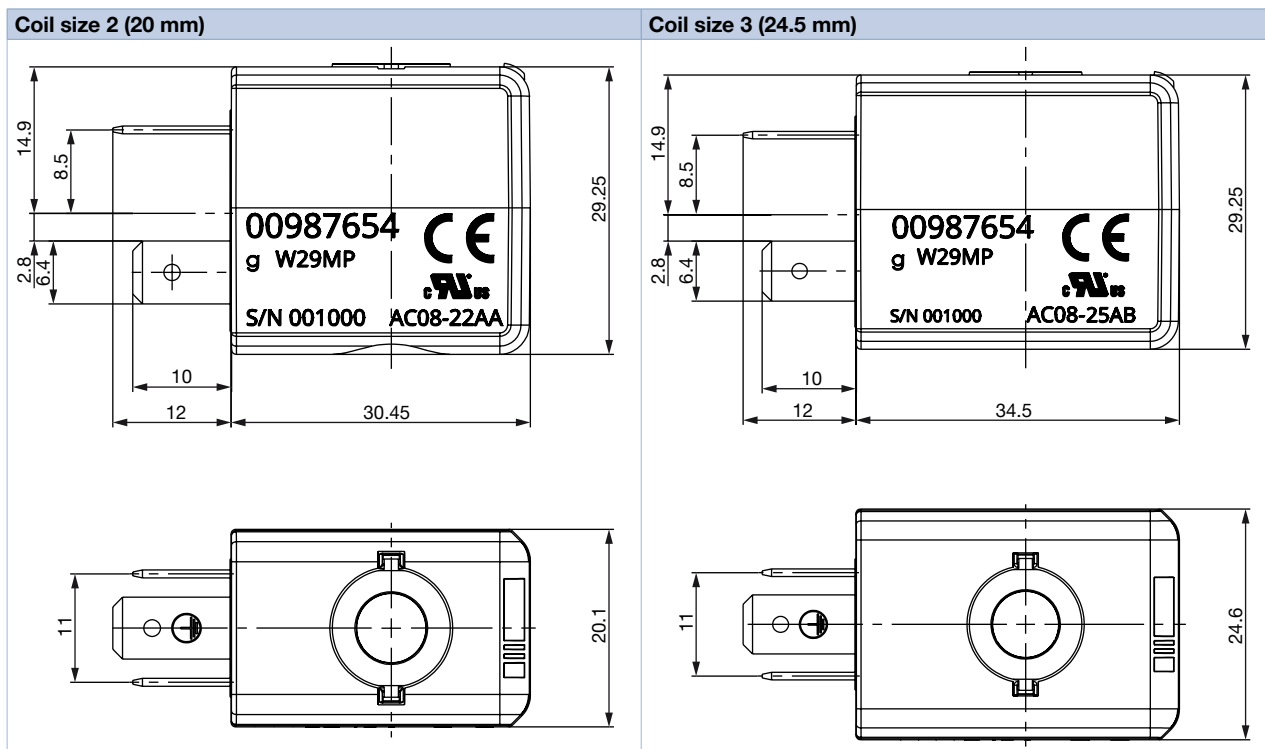

Further electrical connections

- Note:**
- Specifications apply to coil sizes 20 mm and 24.5 mm
 - Dimensions in mm

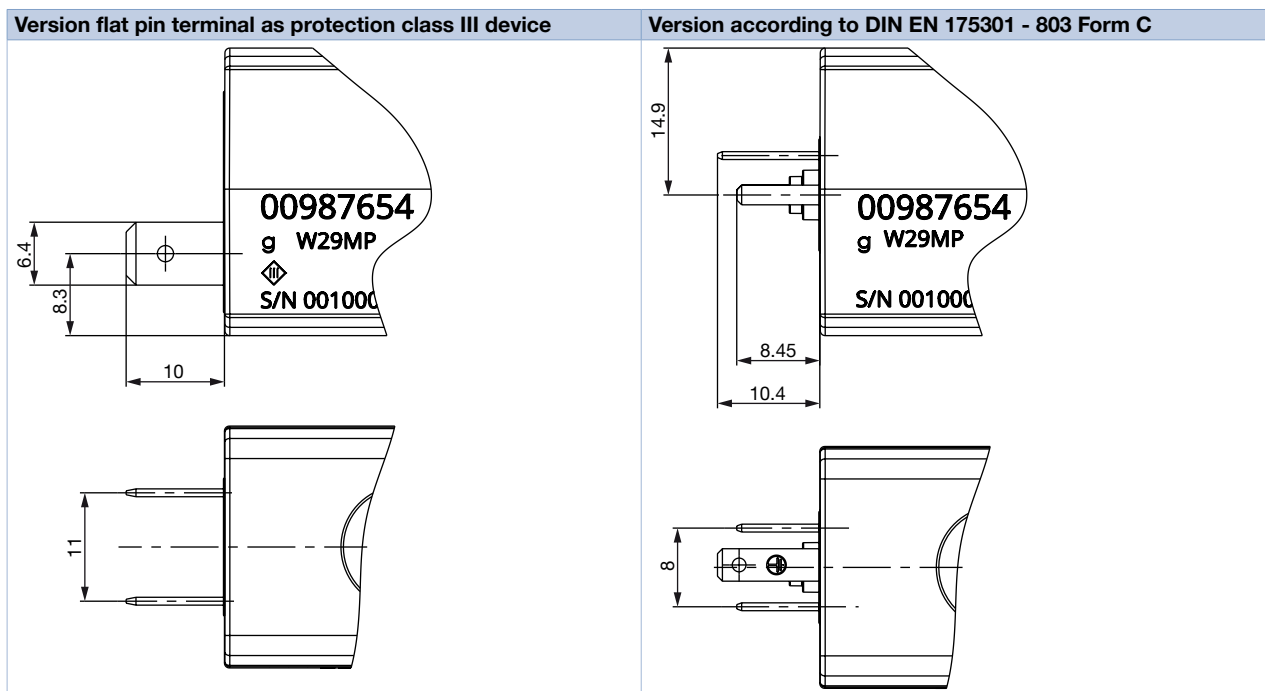

DTS 1000446517 EN Version: B Status: RL (released | freigegeben | valide) printed: 28.01.2021

4.2. Banjo version

Versions according to industry standard Form B, coil size 24.5 mm

Note:

- Dimensions in mm
- Plug connection for compressed air: Pressure port P can be continuously rotated through 360°.
- Available orifices: 1.2 mm

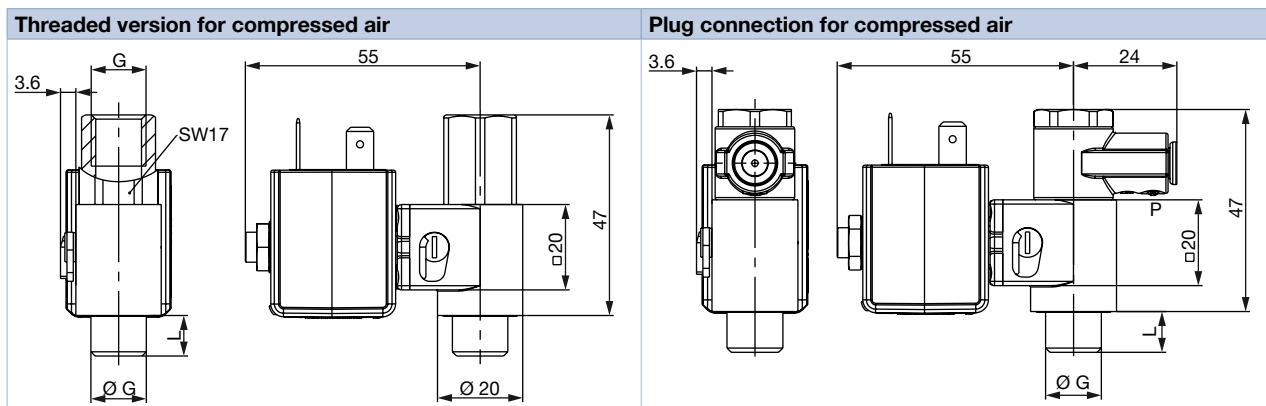

G	L
G 1/8	6.5
G 1/4	9.5

4.3. Multiple manifold

Note:

- Dimensions in mm
- Can only be combined with versions circuit function C (normally closed) and valves with coil size 20 mm
- Manifolds with valves of coil size 24.5 mm on request

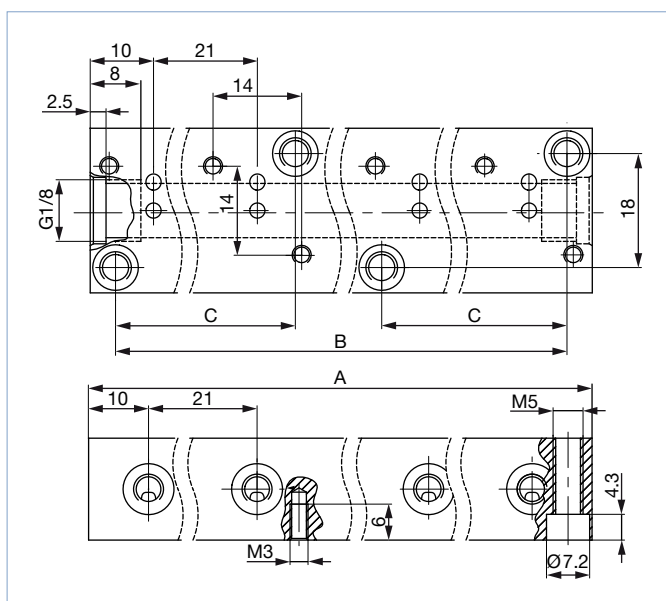

Quantity of valve places	A	B	C	Article no.
	[mm]	[mm]	[mm]	
1	20	12	-	005312
2	41	33	-	005355
3	62	54	-	005313
4	83	75	-	005314
5	104	96	-	005315
6	125	117	-	005316
7	146	138	-	005893
8	167	159	54	005166
9	188	180	54	005241
10	209	201	75	005819
11	230	222	75	005242
12	251	243	96	005222

DTS 1000446517 EN Version: B Status: RL (released | freigegeben | valide) printed: 28.01.2021

5. Performance specifications

5.1. Power consumption of standard coil version 24.5 mm

Coil	Orifice	Electrical power					Switching times ^{1.)}	
		Inrush AC	Hold AC		DC		Opening	Closing
	[mm]	[VA]	[VA]	[W]	Cold [W]	Hot [W]	[ms]	[ms]
24 V / DC / 7 W	1.2	–	–	–	7	5.5	8...12	8...12
	1.6							
24 V / DC / 5.5 W	1.2	–	–	–	5.5	4.5		
	1.6							
24 V / 50 Hz / 4 W	1.2	12	6.5	4	–	–		
	1.6							
230 V / 50 Hz / 4 W	1.2	12	6.5	4	–	–		
	1.6							

1.) Measured at valve outlet at 6 bar^{2.)} and +20 °C according to ISO 12238, opening: pressure rise 0...10 %, closing: pressure drop 100...90 %

2.) Measured as overpressure to the atmospheric pressure and air as a medium

5.2. Power consumption of standard coil version 20 mm

Coil	Orifice	Electrical power					Switching times ^{1.)}	
		Inrush AC	Hold AC		DC		Opening	Closing
	[mm]	[VA]	[VA]	[W]	Cold [W]	Hot [W]	[ms]	[ms]
24 V / DC / 6.5 W	1.2	–	–	–	6.5	5	8...12	8...12
	1.6							
24 V / 50 Hz / 6 W	1.2	11	7	6	–	–		
	1.6							
230 V / 50 Hz / 6 W	1.2	11	7	6	–	–		
	1.6							
24 V / DC / 5 W	1.2	–	–	–	5	4		
	1.6							
24 V / 50 Hz / 4 W	1.2	9	5	4	–	–		
	1.6							
230 V / 50 Hz / 4 W	1.2	9	5	4	–	–		
	1.6							

1.) Measured at valve outlet at 6 bar^{2.)} and +20 °C according to ISO 12238, opening: pressure rise 0...10 %, closing: pressure drop 100...90 %

2.) Measured as overpressure to the atmospheric pressure and air as a medium

6. Ordering information

6.1. Bürkert eShop – Easy ordering and quick delivery



Bürkert eShop – Easy ordering and fast delivery

You want to find your desired Bürkert product or spare part quickly and order directly? Our online shop is available for you 24/7. Sign up and enjoy all the benefits.

[Order online now](#)

6.2. Bürkert product filter



Bürkert product filter – Get quickly to the right product

You want to select products comfortably based on your technical requirements? Use the Bürkert product filter and find suitable articles for your application quickly and easily.











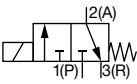



























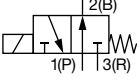

























[Try out our product filter](#)

6.3. Ordering chart

Standard version according to industry standard Form B, coil size 24.5 mm

Note:

All valves without cable plug

Circuit function	Port connection	Orifice	K _v value H ₂ O ⁽¹⁾	Voltage/ Frequency/ Power	Maximum duty cycle	Medium pressure [bar] ^{2) 3)}		Article no. Body material Brass	Article no. Body material stainless steel	
						Ambient temperature 75 °C	Ambient temperature 55 °C			
		[mm]	[m ³ /h]	[V/Hz/W]		Air	Air	FKM seal		
C, solenoid valve 3/2 way Direct-acting Normally closed 	M5	1.2	0.045	24 V / DC / 7 W	100 % ED	–	0...13	380922 	381000 	
				24 V / DC / 5.5 W		0...11.5	390256 	390258 		
				24 V / 50 Hz / 4 W		0...13	380924 	381002 		
				230 V / 50 Hz / 4 W		0...13	380927 	381004 		
		1.6	0.06	24 V / DC / 7 W	100 % ED	–	0...7.5	380932 	381021 	
				24 V / DC / 5.5 W		0...6	390265 	390267 		
				24 V / 50 Hz / 4 W		0...7.5	380931 	381023 		
				230 V / 50 Hz / 4 W		0...7.5	380928 	381025 		
		G 1/8	1.2	0.045	24 V / DC / 7 W	100 % ED	–	0...13	379906 	380132 
							24 V / DC / 5.5 W	0...11.5	390269 	390271 
							24 V / 50 Hz / 4 W	0...13	379928 	380139 
			1.6	0.06	24 V / DC / 7 W	100 % ED	–	0...7.5	379915 	380137 
	24 V / DC / 5.5 W						0...6	390275 	390273 	
	24 V / 50 Hz / 4 W						0...7.5	379930 	380141 	
	D, solenoid valve 3/2 way Direct-acting Normally open 	M5	1.2	0.045	24 V / DC / 5.5 W	100 % ED	0...10	0...10	390363 	390365 
					24 V / 50 Hz / 4 W		0...10	390367 	390382 	
					230 V / 50 Hz / 4 W		0...10	390385 	390384 	
			1.6	0.06	24 V / DC / 5.5 W	100 % ED	0...6	0...6	390390 	390392 
					24 V / 50 Hz / 4 W		0...6	390396 	390398 	
					230 V / 50 Hz / 4 W		0...6	390400 	390401 	
		G 1/8	1.2	0.045	24 V / DC / 5.5 W	100 % ED	0...10	0...10	385475 	390402 
							24 V / 50 Hz / 4 W	0...10	390406 	390409 
							230 V / 50 Hz / 4 W	0...10	390438 	390439 
			1.6	0.06	24 V / DC / 5.5 W	100 % ED	0...6	0...6	390440 	390442 
24 V / 50 Hz / 4 W							0...6	390444 	390446 	
230 V / 50 Hz / 4 W							0...6	390448 	390449 	
FK01	1.2	0.045	24 V / DC / 5.5 W	100 % ED	0...10	0...10	390450 	390452 		
					24 V / 50 Hz / 4 W	0...10	390456 	393085 		
					230 V / 50 Hz / 4 W	0...10	390459 	390460 		
	1.6	0.06	24 V / DC / 5.5 W	100 % ED	0...6	0...6	390462 	390464 		
					24 V / 50 Hz / 4 W	0...6	390468 	390466 		
					230 V / 50 Hz / 4 W	0...6	390470 	390471 		

Standard version according to industry standard Form B, coil size 20 mm

Note:

All valves without cable plug

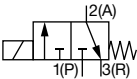
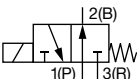
Circuit function	Port connection	Orifice	K _v value H ₂ O ¹⁾	Voltage/ Frequency/ Power	Maximum duty cycle	Medium pressure [bar] ^{2) 3)}		Article no. Body material Brass	Article no. Body material stainless steel
						Ambient temperature 75 °C	Ambient temperature 55 °C		
		[mm]	[m ³ /h]	[V/Hz/W]		Air	Air	FKM seal	
C, solenoid valve 3/2 way Direct-acting Normally closed 	M5	1.2	0.045	24 V / DC / 6.5 W	100% ED	–	0...11	X	X
				24 V / 50 Hz / 6 W		–	0...13	X	X
				230 V / 50 Hz / 6 W		–	0...13	X	X
				24 V / DC / 5 W		0...10	0...10	X	X
				24 V / 50 Hz / 4 W		0...11	0...11	X	X
				230 V / 50 Hz / 4 W		0...11	0...11	X	X
		1.6	0.06	24 V / DC / 6.5 W		–	0...6	X	X
				24 V / 50 Hz / 6 W		–	0...7.5	X	X
				230 V / 50 Hz / 6 W		–	0...7.5	X	X
				24 V / DC / 5 W		0...5.5	0...5.5	X	X
				24 V / 50 Hz / 4 W		0...6	0...6	X	X
				230 V / 50 Hz / 4 W		0...6	0...6	X	X
	G 1/8	1.2	0.045	24 V / DC / 6.5 W	100% ED	–	0...11	X	X
				24 V / 50 Hz / 6 W		–	0...13	X	X
				230 V / 50 Hz / 6 W		–	0...13	X	X
				24 V / DC / 5 W		0...10	0...10	X	X
				24 V / 50 Hz / 4 W		0...11	0...11	X	X
				230 V / 50 Hz / 4 W		0...11	0...11	X	X
		1.6	0.06	24 V / DC / 6.5 W		–	0...6	X	X
				24 V / 50 Hz / 6 W		–	0...7.5	X	X
				230 V / 50 Hz / 6 W		–	0...7.5	X	X
				24 V / DC / 5 W		0...5.5	0...5.5	X	X
				24 V / 50 Hz / 4 W		0...6	0...6	X	X
				230 V / 50 Hz / 4 W		0...6	0...6	X	X
FK01	1.2	0.045	24 V / DC / 6.5 W	100% ED	–	0...11	X	X	
			24 V / 50 Hz / 6 W		–	0...13	X	X	
			230 V / 50 Hz / 6 W		–	0...13	X	X	
			24 V / DC / 5 W		0...10	0...10	X	X	
			24 V / 50 Hz / 4 W		0...11	0...11	X	X	
			230 V / 50 Hz / 4 W		0...11	0...11	X	X	
	1.6	0.06	24 V / DC / 6.5 W		–	0...6	X	X	
			24 V / 50 Hz / 6 W		–	0...7.5	X	X	
			230 V / 50 Hz / 6 W		–	0...7.5	X	X	
			24 V / DC / 5 W		0...5.5	0...5.5	X	X	
			24 V / 50 Hz / 4 W		0...6	0...6	X	X	
			230 V / 50 Hz / 4 W		0...6	0...6	X	X	
D, solenoid valve 3/2 way Direct-acting Normally open 	M5	1.2	0.045	24 V / DC / 5 W	100% ED	0...10	0...10	X	X
				24 V / 50 Hz / 4 W		0...10	0...10	X	X
				230 V / 50 Hz / 4 W		0...10	0...10	X	X
		1.6	0.06	24 V / DC / 5 W		–	0...6	X	X
				24 V / 50 Hz / 4 W		0...6	0...6	X	X
				230 V / 50 Hz / 4 W		0...6	0...6	X	X
	G 1/8	1.2	0.045	24 V / DC / 5 W	100% ED	0...10	0...10	X	X
				24 V / 50 Hz / 4 W		0...10	0...10	X	X
				230 V / 50 Hz / 4 W		0...10	0...10	X	X
		1.6	0.06	24 V / DC / 5 W		–	0...6	X	X
				24 V / 50 Hz / 4 W		0...6	0...6	X	X
				230 V / 50 Hz / 4 W		0...6	0...6	X	X

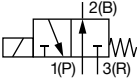
Circuit function	Port connection	Orifice	K _v value H ₂ O ^{1,3}	Voltage/ Frequency/ Power	Maximum duty cycle	Medium pressure [bar] ^{2) 3)}		Article no. Body material Brass	Article no. Body material stainless steel
						Ambient temperature 75 °C	Ambient temperature 55 °C		
		[mm]	[m ³ /h]	[V/Hz/W]		Air	Air	FKM seal	
D, solenoid valve 3/2 way Direct-acting Normally open 	FK01	1.2	0.045	24 V / DC / 5 W	100 % ED	0...10	0...10	X	X
				24 V / 50 Hz / 4 W		0...10	0...10	X	X
				230 V / 50 Hz / 4 W		0...10	0...10	X	X
		1.6	0.06	24 V / DC / 5 W	100 % ED	0...6	0...6	X	X
				24 V / 50 Hz / 4 W		0...6	0...6	X	X
				230 V / 50 Hz / 4 W		0...6	0...6	X	X

X: on request

1.) Flow value for water, measured at +20 °C, 1 bar²⁾ pressure at valve inlet and free outlet

2.) Measured as overpressure to the atmospheric pressure and air as a medium

3.) Number of switching cycles under laboratory conditions (FKM seal, oiled air, unpressurised): 5 million. Please note that an increase in switching pressure can limit the life of the seat seal.

Banjo version, coil size 24.5 mm

Note:

All valves without cable plug

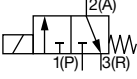
Circuit function	Port connection	Orifice	Q _{Nn} value air	Voltage/ Frequency/ Power	Maximum duty cycle	Medium pressure [bar] ^{1) 2)}		Article no.	
						Ambient temperature 75 °C	Ambient temperature 55 °C		
		[mm]	[l/min]	[V/Hz/W]		Air	Air	FKM seal	
C, solenoid valve 3/2 way Direct-acting Normally closed 	BJ01 P: G 1/8 A: G 1/8	1.2	48	24 V / DC / 7 W	100 % ED	–	0...13	390839	
				24 V / DC / 5.5 W		0...11.5	0...11.5	390842	
				24 V / 50 Hz / 4 W		0...13	0...13	390845	
				230 V / 50 Hz / 4 W		0...13	0...13	390847	
	BJ02 P: G 1/4 A: G 1/4	1.2	48	48	24 V / DC / 7 W	100 % ED	–	0...13	390848
					24 V / DC / 5.5 W		0...11.5	0...11.5	390850
					24 V / 50 Hz / 4 W		0...13	0...13	390852
					230 V / 50 Hz / 4 W		0...13	0...13	390854
	BJ03 P: NPT 1/4 A: G 1/8	1.2	48	48	24 V / DC / 7 W	100 % ED	–	0...13	390855
					24 V / DC / 5.5 W		0...11.5	0...11.5	390858
					24 V / 50 Hz / 4 W		0...13	0...13	390860
					230 V / 50 Hz / 4 W		0...13	0...13	390862
	BJ05 P: G 1/4 A: G 1/8	1.2	48	48	24 V / DC / 7 W	100 % ED	–	0...13	384300
					24 V / DC / 5.5 W		0...11.5	0...11.5	390831
					24 V / 50 Hz / 4 W		0...13	0...13	390832
					230 V / 50 Hz / 4 W		0...13	0...13	390835
	BJ07 P: NPT 1/8 A: G 1/8	1.2	48	48	24 V / DC / 7 W	100 % ED	–	0...13	390864
					24 V / DC / 5.5 W		0...11.5	0...11.5	390867
					24 V / 50 Hz / 4 W		0...13	0...13	390869
					230 V / 50 Hz / 4 W		0...13	0...13	390871
	BJ08 P: Hose connection 6 mm A: G 1/8	1.2	48	48	24 V / DC / 7 W	100 % ED	–	0...13	390875
					24 V / DC / 5.5 W		0...11.5	0...11.5	390880
					24 V / 50 Hz / 4 W		0...13	0...13	390884
					230 V / 50 Hz / 4 W		0...13	0...13	390887
BJ09 P: Hose connection 6 mm A: G 1/4	1.2	48	48	24 V / DC / 7 W	100 % ED	–	0...13	390894	
				24 V / DC / 5.5 W		0...11.5	0...11.5	390905	
				24 V / 50 Hz / 4 W		0...13	0...13	390909	
				230 V / 50 Hz / 4 W		0...13	0...13	390911	

DTS 1000446517 EN Version: B Status: RL (released | freigegeben | valide) printed: 28.01.2021

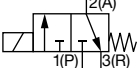
Circuit function	Port connection	Orifice	Q _{Nn} value air	Voltage/ Frequency/ Power	Maximum duty cycle	Medium pressure [bar] ^{1) 2)}		Article no.
						Ambient temperature 75 °C	Ambient temperature 55 °C	
		[mm]	[l/min]	[V/Hz/W]		Air	Air	FKM seal
C, solenoid valve 3/2 way Direct-acting Normally closed 	BJ10 P: G ¼ A: NPT ¼	1.2	48	24 V / DC / 7 W	100 % ED	–	0...13	390916 ☒
				24 V / DC / 5.5 W		0...11.5	0...11.5	390918 ☒
				24 V / 50 Hz / 4 W		0...13	0...13	390922 ☒
				230 V / 50 Hz / 4 W		0...13	0...13	390924 ☒

1.) Measured as overpressure to the atmospheric pressure and air as a medium

2.) Number of switching cycles under laboratory conditions (FKM seal, oiled air, unpressurised): 5 million. Please note that an increase in switching pressure can limit the life of the seat seal.

Additional options

Note:

Available on request

Option	Variable Code	Description
Oxygen versions	NL02	Suitable for applications with oxygen (non-metal materials that are in contact with the medium are tested and approved according to BAM)
Increased purity requirements e.g. oil, grease and silicone-free	NL50/NL05	Wetted parts are specially cleaned and packaged in accordance with the valves
Increased tightness requirements	PC05	Leakage rate *less than 10 ⁻⁴ mbar l/sec
	PC08	Leakage rate *less than 10 ⁻⁵ mbar l/sec
	PC06	Leakage rate *less than 10 ⁻⁶ mbar l/sec
Vacuum version	on request	–





6.4. Ordering chart accessories

Accessories for manifolds

Accessory	Features	Article no.
Screw plug	With sealing ring, G ⅛	005041 ☒
Cover plate	For unoccupied valve position	005100 ☒





Cable plug Type 2516 acc. to DIN EN 175301 -803 Form C
Note:

- Delivery of cable plug includes a flat seal and a fixing screw.
- Further versions of cable plug with circuitry acc. to DIN EN 175 301 -803 Form C as well as detailed technical data, see data sheet **Type 2516** ▶.

Cable plug	Version	Voltage	Article no.
	Without circuitry (standard)	0...250 V AC/DC	303141 
	With LED	12...24 V AC/DC	303145 
	With LED and varistor	12...24 V AC/DC	303148 
	With rectifier, LED and varistor	12...24 V AC/DC	303142 

Cable plug Type 2507 acc. to industry standard Form B
Note:

- Delivery of cable plug includes a flat seal and a fixing screw.
- Further versions of cable plug with circuitry acc. to industry standard connector Form B as well as detailed technical data, see data sheet **Type 2507** ▶.

Cable plug	Version	Voltage	Article no.
	Without circuitry (standard)	2...250 V AC/DC	423845 
	With LED	24 V AC/DC	423849 
	With LED and free-wheeling diode	12...24 V AC/DC	423851 
	With rectifier, LED and varistor	12...24 V AC/DC	423853 

Bürkert – Close to You

For up-to-date addresses
please visit us at
www.burkert.com

DTS 1000446517 EN Version: B Status: RL (released | freigegeben | validé) printed: 28.01.2021

