



Typ 5404 kombinierbar mit

**Type 2508**

Cable plug

**Type 1078**

Timer unit

**Type 2511**

ASI cable plug

Servo-assisted 2/2-way piston valve

- Servo-assisted piston valve with diameter of up to DN 25
- Vibration-proof, screwed coil system
- Moulded housing with high surface quality
- Explosion proof versions
- Suitable for gas and steam applications

The 5404 valve is a servo-assisted piston valve available in both NC and NO versions. A minimum differential pressure is required for the valve switching function. The standard brass housing satisfies all European drinking water requirements. The solenoid coils are moulded with high-quality polyamide. For reduced energy requirement, all coils can be delivered with electronic power reduction. In combination with a plug in accordance with DIN EN 17301-803 Form A, the valves satisfy protection class P65.

Circuit function A

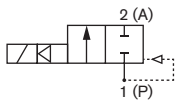

2/2-way valve NC,
normally closed

Circuit function B

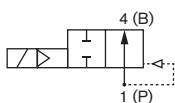

2/2-way valve NO,
normally open

Technical data	
Orifice	DN 12 - 25 mm
Body material	Brass
Coil material	Polyamide
Coil insulation class	B (H on request)
Valve internals	Stainless steel, brass
Seal material	PTFE seat seal + NBR PTFE seat seal + FKM
Media	Neutral media, compressed air, water, hydraulic oil
Media temperature	0 to +100 °C
Ambient temperature	Max. +55 °C
Voltage tolerance	±10 %
Duty cycle	100% continuous rating
Electrical connection	Steckerfahnen nach DIN EN 175301-803 (ehemals DIN 43650) Form A für Gerätesteckdosen Typ 2508 (siehe Zubehör)
Protection class	IP 65 with cable plug
Installation	As required, preferably with actuator upright

Response times	
Opening [ms]	20-400
Closing [ms]	100-1500 (depending on orifice and differential pressure)

Power consumption			
Standard Inrush AC [VA]	Hold AC (hot coil) [VA]		Hold DC (hot/cold coil) [W]
Circuit function A			
24	14	8	8/9.5
Circuit function B			
24	16	7	8/9.5
Ex Coil ¹⁾ (Circuit function A)			
9	9		9

¹⁾ with internal rectifier

Materials

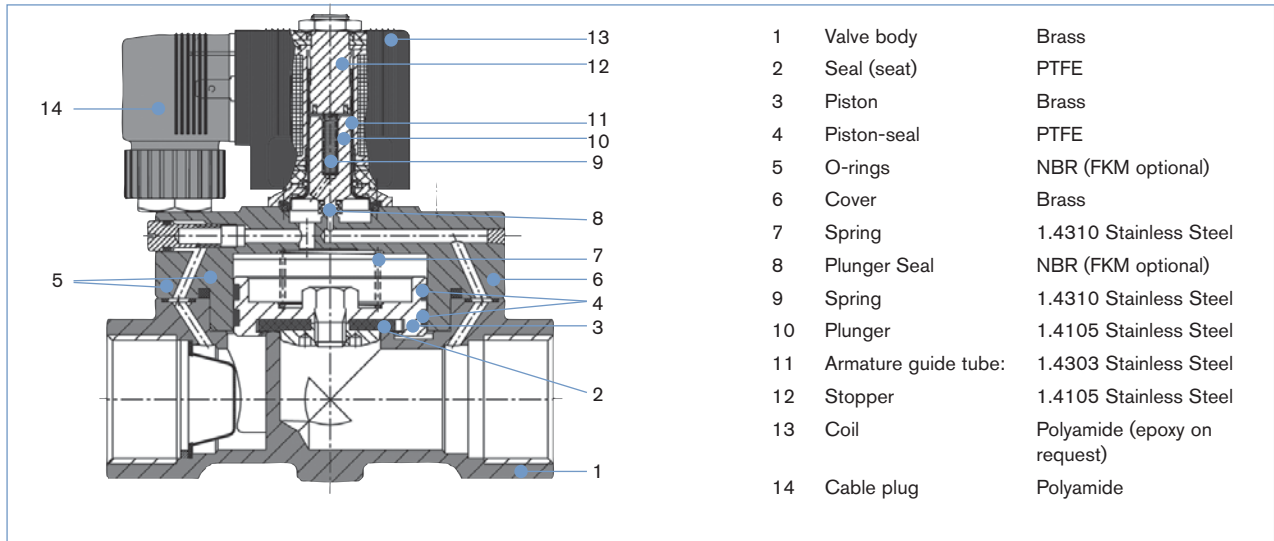

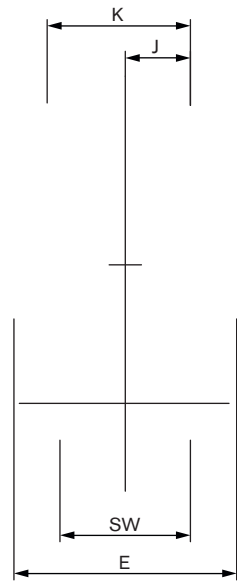
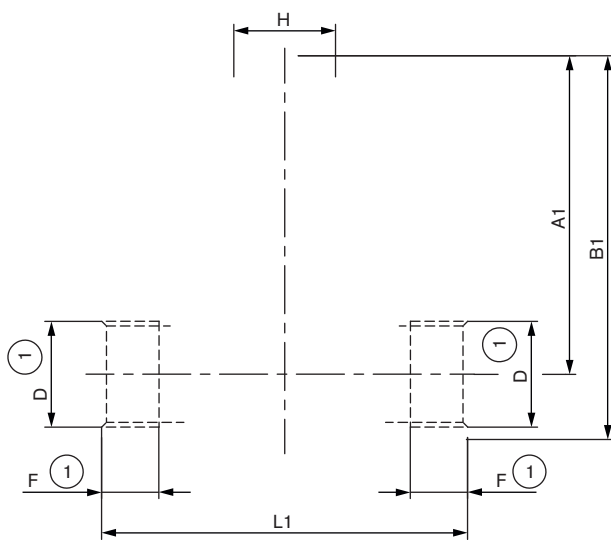
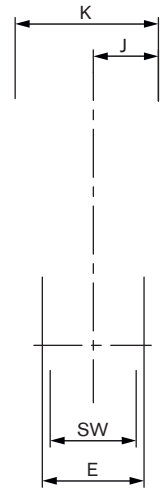
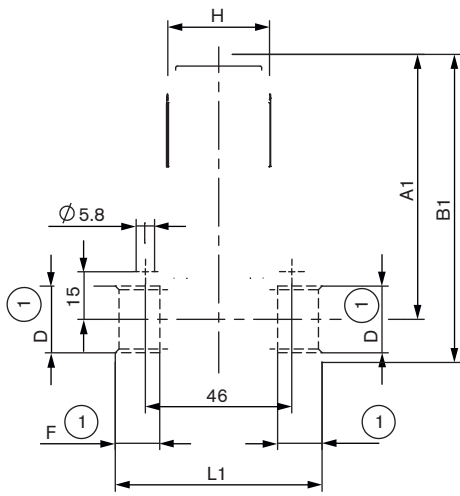

Ordering chart for valves - Standard version (other versions on request)

Circuit function A (NC, normally closed), brass body; delivered without cable plug

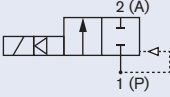
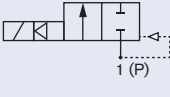
Circuit function	Port connection	Orifice [mm]	Kv value water [m³/h]	Pressure range for liquids [bar]	pressure range for gases [bar]	Item no. per voltage/frequency [V/Hz]		
						024/DC	024/50	230/50
PTFE + NBR								
A 2/2-way valve, NC 	G 1/2	12	2.0	1 - 50	1 - 50	134 590	134 591	134 593
	G 3/4	20	5.0	1 - 25	1 - 32	134 594	-	-
				1 - 25	1 - 40	-	134 595	134 597
	G 1	25	10.0	1 - 25	1 - 32	134 598	-	-
				1 - 25	1 - 40	-	134 599	134 601
PTFE + FKM								
A 2/2-way valve, NC 	G 1/2	12	2.0	1 - 50	1 - 50	140 564	140 565	140 566
	G 3/4	20	5.0	1 - 25	1 - 32	X	-	-
				1 - 25	1 - 40	-	X	X
	G 1	25	10.0	1 - 25	1 - 32	189 860	-	-
				1 - 25	1 - 40	-	X	X

Circuit function B (NO, normally open), internal feedback, brass body; delivered without cable plug

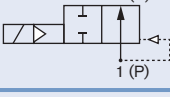
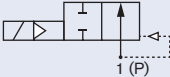
Circuit function	Port connection	Orifice [mm]	Kv value water [m³/h]	Pressure range for liquids [bar]	pressure range for gases [bar]	Item no. per voltage/frequency [V/Hz]		
						024/DC	024/50	230/50
PTFE + NBR								
B 2/2-way valve, NO 	G 1/2	12	2.0	1 - 40	1 - 40	X	X	X
	G 3/4	20	5.0	1 - 25	1 - 25	X	X	X
	G 1	25	10.0	1 - 25	1 - 25	X	X	X
PTFE + FKM								
B 2/2-way valve, NO 	G 1/2	12	2.0	1 - 40	1 - 40	X	X	X
	G 3/4	20	5.0	1 - 25	1 - 25	X	254 636	X
	G 1	25	10.0	1 - 25	1 - 25	X	X	X

X on request

Dimensions [mm] - ATEX/IECEX version

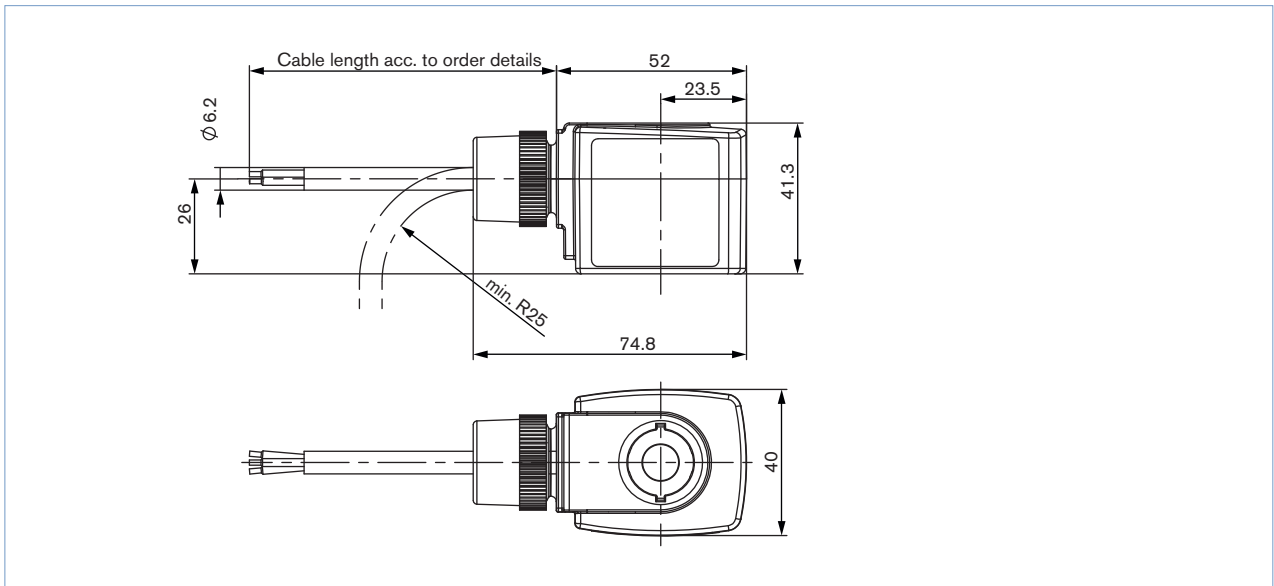

ordering chart for valves - ATEX/IECEX versions (other versions on request)

Circuit function A (NC, normally closed), brass body; delivered without cable plug

The maximum fluid temperature must not in any case exceed the permissible temperature class (T4 135 °C, 100 °C T5, T6 85 °C), of minus 5 K.

Circuit function	Port connection	Orifice [mm]	Kv value water [m³/h]	Pressure range for liquids [bar]	pressure range for gases [bar]	Item no. per voltage/frequency [V/Hz]	
						024/UC	230/UC
PTFE + NBR							
A 2/2-way valve, NC 	G 1/2	12	2.0	1-50	1-50	X	278 115
	G 3/4	20	5.0	1-25	1-32	X	X
	G 1	25	10.0	1-25	1-32	X	X
PTFE + FKM							
A 2/2-way valve, NC 	G 1/2	12	2.0	1-50	1-50	278 117	278 118
	G 3/4	20	5.0	1-25	1-32	X	278 121
	G 1	25	10.0	1-25	1-32	X	X

X on request

Explosion-proof approvals

ATEX: PTB 14 ATEX 2023 X

II 2G Ex mb IIC T4 Gb

II 2D Ex mb IIIC T135 °C Db

IECEX: IECEX PTB 14.0049 X

Ex mb IIC T4 Gb

Ex mb IIIC T135 °C Db

Note: the pressure values for liquid media are shown on the rating plate!

Please note that the cable plug has to be ordered separately, see Ordering chart for accessory below and separate datasheet, Type 2508

i Further versions on request



Approvals

UL, UR, CSA, Hazardous Locations Expl. proof, EEx m/ed



Voltage

110/50, non-standard voltages

Ordering chart for accessories

Cable plug Type 2508 according to DIN EN 175301-803 Form A

	Circuitry	Voltage / frequency	Item no.
	None (standard)	0 - 250 V AC/DC	008 376
	with LED	12 - 24 V AC/DC	008 360
	with LED and varistor	12 - 24 V AC/DC	008 367
	with rectifier, LED and varistor	12 - 24 V AC/DC	008 363
	with LED	200 - 240 V	008 362
	with LED and varistor	200 - 240 V	008 369
further versions see datasheet Type 2508			

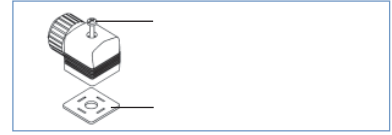

The delivery of a cable plug includes the flat seal and the fixing screw. For other cable plug versions acc. to DIN EN 175301-803 Form A (previously DIN 43650), see separate datasheet Type 2508.