

## multiCELL - Multi-channel and multi-function transmitter/controller



- Compatible with most common flow, pH/ORP, chlorine and conductivity sensors
- Simple, intuitive user interface with a large adjustable backlit graphics display (4 user defined views)
- Hardware extension possibilities (up to 6 free slots)
- Industrial Ethernet (Modbus TCP, PROFINET or EtherNet/IP) option available
- Functionality extendable by software options

Type 8619 can be combined with...



**Type 8200**  
pH/ORP sensor

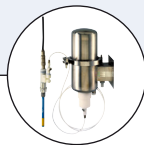

**Type 8201**  
pH system

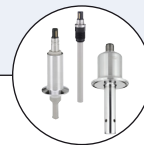

**Type 8221**  
Conductivity sensor

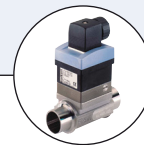

**Type 8030**  
Inline flowmeter



**Type 8232**  
Chlorine sensor

The 8619 multichannel and multifunction transmitter/controller, available in two housing variants for panel or wall mounting, is a microprocessor transmitter/controller for connection of sensors which deliver raw signals for pH, ORP, conductivity and flow via pulses or sensors (like pressure, level, chlorine...) which delivers analogue signals (0...20 mA, 4...20 mA, 0...2 V, 0...5 V, 0...10 V).

Type 8619 is the ideal device for measurement and control and as well dosing processes e.g. in applications of water treatment plants (like boiler, cooling tower or reverse osmosis systems) and food and pharma plants. Modularity in hardware and software offers high flexibility for adjusting it to the applications resulting in having a very good price to functionality relation.

Sophisticated electronics and state of the art control algorithms ensure that optimum process control is maintained at all times with minimal operator intervention and achieving highest quality.

Thanks to full support of the Modbus TCP, PROFINET (Conformance Class B) or EtherNet/IP, the 8619 can be integrated into most Industrial Ethernet environments. Therefore all important process values like measurement data, process diagnostics or device status can be easily integrated into the automation system.

General data	
<b>Mounting</b>	Panel-mounted (standardized ¼ DIN housing for 92 x 92 mm cutout) Wall-mounted (with mounting plate)
<b>Materials</b>	Please refer to description on page 3. Silicone / Stainless steel 316 (A4) Stainless steel 304 PBT, contact in gold-plated copper alloy Contact in gold-plated copper alloy, thermoplastic PC / Silicone
Seal / Screws Support plate for terminals Terminal blocks Port for an RJ45 connector Display / Front panel and keys Housing Panel-mounted Wall-mounted	PPO (incl. fastening element) PA66 (incl. fastening plate, cable gland, protecting cover (display), protecting cap (free terminal place), stiffener hinge) PVC
Cover screws (wall-mounted version) Protective cap (110...240 V AC supplied wall-mounted version)	Stainless steel 304
<b>Display</b>	LC graphic display, light blue backlit; 128 x 168 pixels resolution; German, English, French languages
<b>Keypad</b>	4 soft keys [F1] [F2] [F3] [F4] for dynamic functions 1 central navigation key with [↑] [↓] [→] [←] assignments
<b>Data logger</b>	up to 16 values
<b>Sensor monitor</b>	Direct display and verification of measured sensor values
<b>Clock</b>	Real-time clock with date
<b>Module slots</b>	6

Electrical data		
Device version	Panel-mounted – Main module	Wall-mounted – Power supply module
<b>Operating voltage</b> ("SUPPLY")	12...36 V DC <sup>1)</sup> ±10 %, max. 2 A, filtered and regulated, SELV (safety extra low voltage) circuit with a non dangerous energy level	<ul style="list-style-type: none"> <li>• 12...36 V DC<sup>1)</sup> ±10 %, max. 2 A, filtered and regulated, SELV (safety extra low voltage) circuit with a non dangerous energy level</li> <li>• 110...240 V AC, 50...60 Hz, max. 550 mA, integrated protection: 3.15 A time delay fuse ground cable cross-section: 1.5 mm<sup>2</sup></li> </ul>
<b>Power consumption</b> (of multiCELL device - without additional modules and outputs not connected)	Max. 1.5 VA	Max. 2 VA
<b>Power charges</b> ("PWR OUT" or "POWER OUT" acc. to version)	12...36 V DC <sup>1)</sup> , max. 1.8 A protected against polarity reversals	<ul style="list-style-type: none"> <li>• 12...36 V DC<sup>1)</sup> version: 12...36 V DC<sup>1)</sup>, max. 1.8 A; protected against polarity reversals</li> <li>• 110...240 V AC version: 24 V DC ±2 %, filtered and regulated, SELV (safety extra low voltage) circuit with a non dangerous energy level, max. 1.3 A protected against polarity reversals The allowed max. current depends on the ambient temperature: see diagram below</li> </ul>
<b>Device version</b>	<b>Panel-mounted – Main module, pH/ORP, conductivity, input and output modules</b>	<b>Wall-mounted – Main module, pH/ORP, conductivity, input and output modules</b>
<b>Electrical connection</b>	Terminal blocks or hybrid RJ45 connector	Terminal blocks or RJ45 connector
<b>Recommended cable</b>	Cable with maximum operating temperature greater than +90 °C (+194 °F)	Cable with maximum operating temperature greater than +90 °C (+194 °F)
External diameter	–	6...12 mm (4 mm if using a multiple entry seal)
Cross section of	–	–
• Earth connection conductor	0.75...1.5 mm <sup>2</sup>	min. 1.5 mm <sup>2</sup>
• Rigid H05(07) V-U	0.2...1.5 mm <sup>2</sup> , stripped over 7 mm, shielded cable	0.2...1.5 mm <sup>2</sup> , stripped over 7 mm, shielded cable
• Flexible H05(07) V-K	0.2...1.5 mm <sup>2</sup> , stripped over 7 mm, shielded cable	0.2...1.5 mm <sup>2</sup> , stripped over 7 mm, shielded cable
• Conductor with non-insulated lug	0.2...1.5 mm <sup>2</sup> , stripped over 7 mm, shielded cable	0.2...1.5 mm <sup>2</sup> , stripped over 7 mm, shielded cable
• Conductor with an insulated lug	0.2...0.75 mm <sup>2</sup> , stripped over 7 mm, shielded cable	0.2...0.75 mm <sup>2</sup> , stripped over 7 mm, shielded cable
<b>Device version</b>	<b>Panel-mounted – Main module</b>	<b>Wall-mounted – Main module</b>
<b>Digital inputs</b> <b>DI1, DI2</b>	Voltage: 0...36 V DC <sup>1)</sup> , input impedance 3 kΩ Switching threshold: V <sub>on</sub> = 5...36 V DC <sup>1)</sup> , V <sub>off</sub> < 2 V DC; Frequency: 0.5...2500 Hz Galvanic insulation, protected against reversed polarity of DC and voltage spikes	Voltage: 0...36 V DC <sup>1)</sup> , input impedance 3 kΩ Switching threshold: V <sub>on</sub> = 5...36 V DC <sup>1)</sup> , V <sub>off</sub> < 2 V DC; Frequency: 0.5...2500 Hz Galvanic insulation, protected against reversed polarity of DC and voltage spikes
<b>Digital outputs</b> <b>DO1, DO2</b>	Transistor: can be wired as PNP or NPN, galvanic insulation, protected against short circuit, max. 36 V DC <sup>1)</sup> , max. 700 mA if 1 DO per module is activated, max. 1 A if the 2 DO's per module are activated, max. 4 A for an Ethernet version if the device has 4 output modules; Operating modes: On/Off, Hysteresis, Window, PWM, PFM, Pulse; Frequency: max. 2000 Hz	Transistor: can be wired as PNP or NPN, galvanic insulation, protected against short circuit, max. 36 V DC <sup>1)</sup> , max. 700 mA if 1 DO per module is activated, max. 1 A if the 2 DO's per module are activated, max. 4 A for an Ethernet version if the device has 4 output modules; Operating modes: On/Off, Hysteresis, Window, PWM, PFM, Pulse; Frequency: max. 2000 Hz
<b>Analogue output</b> <b>AO1, AO2</b>	4...20 mA, can be wired as sourcing or sinking, galvanic insulation, protected against reversed polarity of DC, max. loop impedance: 860 Ω at 30 V DC, 610 Ω at 24 V DC, 100 Ω at 12 V DC Resolution: 6 μA	4...20 mA, can be wired as sourcing or sinking, galvanic insulation, protected against reversed polarity of DC, max. loop impedance: 1100 Ω at 36 V DC <sup>1)</sup> , 610 Ω at 24 V DC, 100 Ω at 12 V DC Resolution: 6 μA
<b>Memory card</b> Type / Capacity	SD (Secure Digital) or SDHC (Secure Digital High Capacity) / max. 8 GB Note: We recommend to use the 8 GB SDHC memory card available at Bürkert (see accessories on page 14) because it has been tested with and validated for the 8619 Transmitter/Controller. Another memory card may not operate correctly. With 8 values recorded every 10 sec., the 8 GB card allows continuous recording over 500 days	

<sup>1)</sup>  If the device is mounted in a humid environment or outside, then the maximum voltage allowed is **35 V DC** instead of 36 V DC.

**Further technical data**

**Max. allowed current in dependence of the ambient temperature** (for wall-mounted version, 110...240 V AC)

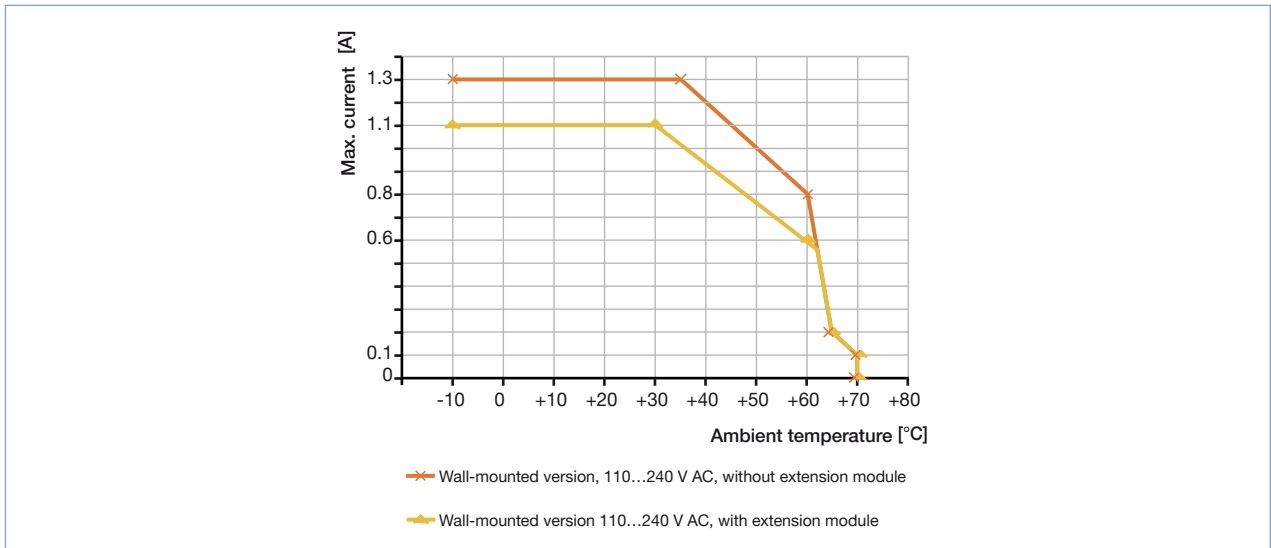

**Materials**

Panel-mounted (shown with Ethernet version)

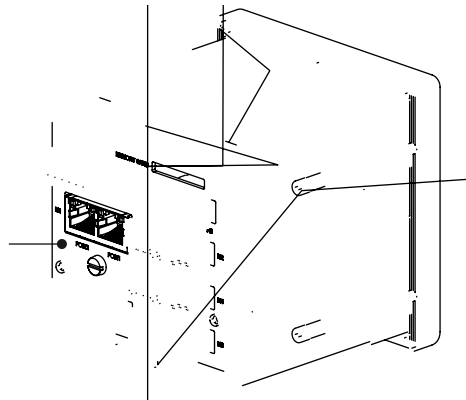
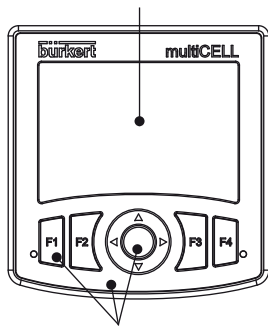

## Additional modules

Five different types of modules are available and can be inserted into any of the 6 slots (preconfigured at the factory)

- input module: 2 analogue inputs (4...20 mA or 0...20 mA or 0...2 V or 0...5 V or 0...10 V) and 2 digital inputs (static or frequency/pulse).
- output module: 2 transistor outputs and 2 analogue 4...20 mA outputs
- input pH/ORP and Pt100/Pt1000 modules
- input conductivity and Pt100/Pt1000 modules
- Ethernet module: Modbus TCP, PROFINET Conformance Class B and EtherNet/IP

Technical data – input module	
<b>Power consumption</b>	0.1 VA
<b>Analogue inputs AI1, AI2</b>	can be wired as sourcing or sinking, galvanic insulation
Current	range: 0 or 3.5...22 mA max. voltage: 36 V DC <sup>1)</sup> impedance: 50 Ω resolution: 1.5 µA
Voltage	range: 0...2 or 5 or 10 V DC max. voltage: 36 V DC <sup>1)</sup> impedance: 110 kΩ resolution: 1 mV
Error	±0.25 % of measured value
<b>Digital inputs DI1, DI2</b>	Voltage: 0...36 V DC <sup>1)</sup> , input impedance 3 kΩ Switching threshold : $V_{on} = 5...36 \text{ V DC}^{1)}$ , $V_{off} < 2 \text{ V DC}$ ; Frequency: 0.5...2500 Hz Galvanic insulation, protected against reversed polarity of DC and voltage spikes

Technical data – output module	
<b>Power consumption</b>	Max. 0.1 VA
<b>Digital outputs DO1, DO2</b>	Transistor: can be wired as PNP or NPN, galvanic insulation, protected against short circuit, max. 36 V DC <sup>1)</sup> , max. 700 mA if 1 DO per module is activated, max. 1 A if the 2 DO's per module are activated, max. 4 A for an Ethernet version if the device has 4 output modules; Operating modes: On/Off, Hysteresis, Window, PWM, PFM; Frequency: max. 2000 Hz
<b>Analogue output AO1, AO2</b>	4...20 mA, can be wired as sourcing or sinking, galvanic insulation, protected against reversed polarity of DC, max. loop impedance: 1100 Ω at 36 V DC <sup>1)</sup> , 610 Ω at 24 V DC, 100 Ω at 12 V DC Resolution: 6 µA
<b>4...20 mA output uncertainty</b>	±0.5 % of the transmitted value

Technical data – pH/ORP module	
<b>Power consumption</b>	0.1 VA
<b>pH/ORP input</b>	Simultaneous pH and ORP measurement with input for electrochemical pH/ORP
<b>Temperature input</b>	Pt100/Pt1000, 2 or 3 wires
<b>pH measurement</b>	Measuring range -2.0...+16 pH or -600...+600 mV Resolution 0.01 pH or 0.1 mV Measurement deviation ±0.02 pH or 1 mV + error of the pH probe* Probe type electrochemical
<b>ORP measurement</b>	Measuring range -2000...+2000 mV Resolution 0.1 mV Measurement deviation ±1 mV + error of the ORP probe* Probe type electrochemical
<b>Temperature measurement</b>	Measuring range -25...+130 °C (-20...+266 °F) Resolution 0.1 °C (0.18 °F) Measurement deviation ±1 °C (1.8 °F) + error of the temperature probe* Probe type Pt100/Pt1000, 2 or 3 wires

\* see related probe data sheet

Technical data – conductivity module	
<b>Resistance measurement</b>	(without conductivity probe connected) 5.0 Ω...1 MΩ
<b>Power consumption</b>	0.25 VA
<b>Conductivity input</b>	Operation with 2 or 4 pin technology sensors
<b>Temperature input</b>	Pt100/Pt1000, 2 or 3 wires
<b>Conductivity measurement</b>	(with connected conductivity probe) Measuring range 0 µS/cm...2 S/cm (depending on the conductivity cell) Resolution 1 nS/cm Measurement deviation ±0.5 % of measured value + error of the conductivity probe*
<b>Resistivity measurement</b>	(with connected conductivity probe) Measuring range 0.5 Ω.cm...100 MΩ.cm (depending on the conductivity cell) Resolution 0.1 Ω.cm Measurement deviation ±0.5 % of measured value + error of the conductivity probe*
<b>Temperature measurement</b>	Measuring range -40...+200 °C (-40...+392 °F) Resolution 0.1 °C (0.18 °F) Measurement deviation ±1 °C (1.8 °F) + error of the temperature probe* Probe type Pt100/Pt1000, 2 or 3 wires



\* see related probe data sheet

<sup>1)</sup>  If the device is mounted in a humid environment or outside, then the maximum voltage allowed is **35 V DC** instead of 36 V DC.

Technical data – Ethernet module	
<b>Power consumption</b>	2.2 VA
<b>Supported network protocols</b>	Modbus TCP, PROFINET or EtherNet/IP
<b>LEDs</b>	<ul style="list-style-type: none"> <li>• 2 Link/Act LEDs (yellow)</li> <li>• 2 Link LEDs (green)</li> </ul>
<b>Electrical connection</b>	2 ports for an RJ45 connector (Not provided – Note: to make sure the door of a wall-mounted Ethernet version can be fully closed, use RJ45 male connectors with maximum dimensions of 45 mm, including the bend radius of the Ethernet cable.)
<b>Recommended cable</b>	minimum required: FTP
Shielded cable	5e / CAT-5
Minimum category	
Length	maximum 100 m
<b>Modbus TCP protocol</b>	
Protocol	Internet protocol, version 4 (IPv4)
Network topology	<ul style="list-style-type: none"> <li>• Tree</li> <li>• Star</li> <li>• Line (open daisy chain)</li> </ul>
IP configuration	<ul style="list-style-type: none"> <li>• Fixed IP</li> <li>• BOOTP (Bootstrap Protocol)</li> <li>• DHCP (Dynamic Host Configuration)</li> </ul>
Transmission speed	10 or 100 MBit/s
<b>PROFINET protocol</b>	
PROFINET IO specification	V2.3
Network topology	<ul style="list-style-type: none"> <li>• Tree</li> <li>• Star</li> <li>• Ring (closed daisy chain)</li> <li>• Line (open daisy chain)</li> </ul>
Network management	<ul style="list-style-type: none"> <li>• LLDP (Link Layer Discovery Protocol)</li> <li>• SNMP V1 (Simple Network Management Protocol)</li> <li>• MIB (Management Information Base)</li> <li>• DCP (Discovery and Configuration Protocol)</li> <li>• Manual (Device naming and IP setting)</li> </ul>
IP configuration	100 MBit/s full duplex
Transmission speed	100 MBit/s full duplex
Maximum supported conformance class	CC-B
Media Redundancy (for ring topology)	MRP client is supported
GSDml file	Available at / Download from: <a href="http://www.burkert.com">www.burkert.com</a>
<b>EtherNet/IP</b>	
Protocol	Internet protocol, version 4 (IPv4)
Network topology	<ul style="list-style-type: none"> <li>• Tree</li> <li>• Star</li> <li>• Ring (closed daisy chain)</li> <li>• Line (open daisy chain)</li> </ul>
IP configuration	<ul style="list-style-type: none"> <li>• Fixed IP</li> <li>• BOOTP (Bootstrap Protocol)</li> <li>• DHCP (Dynamic Host Configuration Protocol)</li> </ul>
Transmission speed	10 or 100 MBit/s
Duplex modes	Half duplex, full duplex, auto-negotiation
MDI modes (Medium Dependant Interface)	auto-MDIX
Predefined standard objects	Identity, Message Router, Assembly, Connection Manager, DLR, QoS, TCP/IP Interface, Ethernet Link object
Device specified objects	I/O main board M0, Functions, Extension modules, Ethernet module
EDS file	Available at / Download from: <a href="http://www.burkert.com">www.burkert.com</a>

Environment conditions – Main module, pH/ORP, conductivity, input, output and Ethernet modules	
<b>Ambient temperature</b>	
Operation (with/without memory card)	<ul style="list-style-type: none"> <li>• Panel-mounted and 110...240 V AC wall-mounted version: -10...+70 °C (+14...+158 °F)</li> <li>• 12...36 V DC<sup>1)</sup> wall-mounted version: -10...+75 °C (+14...+167 °F)</li> </ul>
Only Main module	
Min. 1 additional module	<ul style="list-style-type: none"> <li>• all versions: -10...+60 °C (+14...+140 °F)</li> </ul>
Storage	<ul style="list-style-type: none"> <li>• all versions: -20...+70 °C (-4...+140 °F), limited to -10...+70 °C (+14...+140 °F) if memory card is inserted</li> </ul>
<b>Relative humidity</b>	< 85 %, without condensation
<b>Height above sea level</b>	max. 2000 m

<sup>1)</sup> if a different memory card is used, observe the operating temperatures specified by its manufacturer

Standards, directives and certifications – Main module, pH/ORP, conductivity, input, output and Ethernet modules	
<b>Protection class</b>	acc. to EN 60529
Panel-mounted version	IP65 (panel-mounted, cabinet closed) IP20 (panel-mounted, inside the cabinet) NEMA250 4X (panel-mounted, in front of the closed cabinet)
Wall-mounted version	IP65, IP67, if the following conditions are met: - glands body tightened with a tightening torque of 5.5 Nm ±20 %, made at factory - glands blanked off or wired - gland nuts tightened with a tightening torque of 4.5 Nm ±20 % - housing closed - 4 screws of cover cross tightened with a tightening torque of 1.4 Nm ±20 %
<b>Standard and directives CE</b>	The applied standards, which verify conformity with the EU Directives, can be found on the EU Type Examination Certificate and/or the EU Declaration of conformity (if applicable)
<b>Certifications</b>	
UL-Listed for USA and Canada	 Measuring Equipment E237737 61010-1 + CAN/CSA-C22.2 No. 61010-1
PROFINET	 PROFINET Z11949
EtherNet/IP	

**!** If the device is mounted in a humid environment or outside, then the maximum voltage allowed is **35 V DC** instead of 36 V DC.

Specific technical data of UL-Listed products for US and Canada	
<b>Intended for an inner pollution input</b> V DC version V AC version	Pollution degree 2 acc. to EN 61010-1 Pollution degree 3 acc. to EN 61010-1 if the following conditions are met: - housing tightly closed. - the 4 screws of the cover are tightened crosswise at a torque of 1.4 Nm $\pm$ 20 %
<b>Installation category</b> V DC version V AC version	Category I according to UL 61010-1 Category II according to UL 61010-1

## Dimensions [mm]

### Panel-mounted

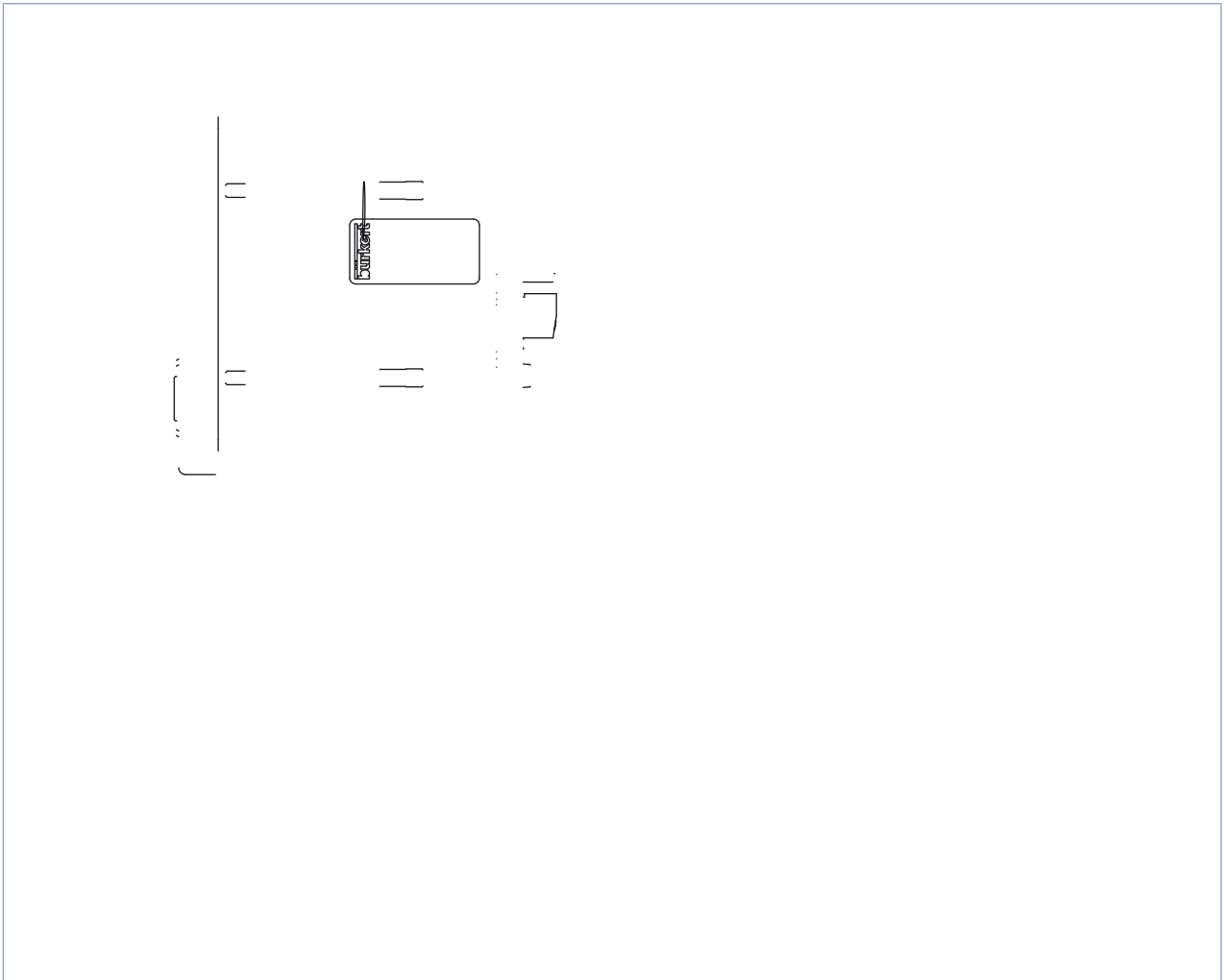

## Dimensions [mm]

### Wall-mounted

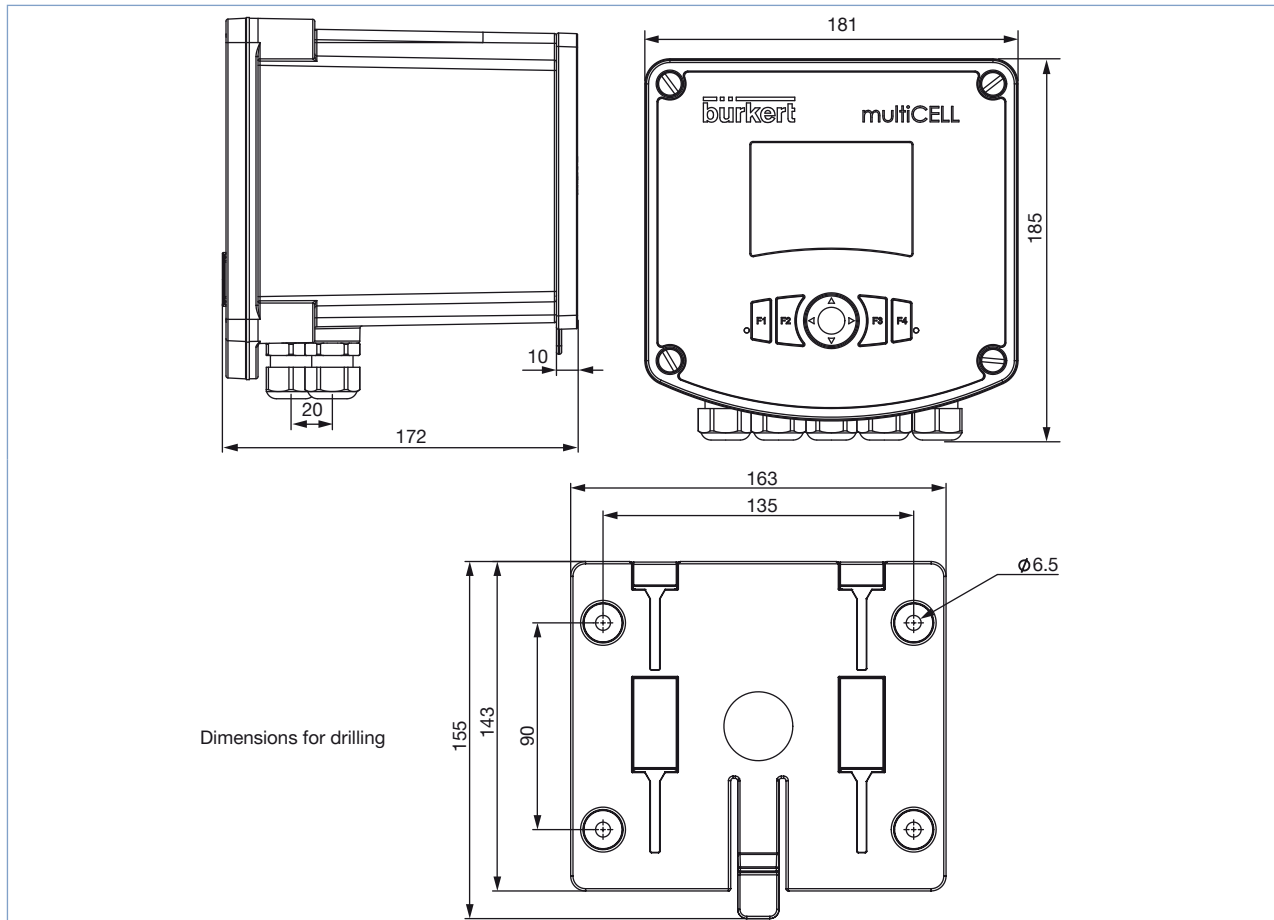

The housing variant for wall mounting can also be installed on a pipe using a mounting set (has to be ordered separately, see accessories on page 14).

## Principle of operation

Thanks to its modular internal structure, the transmitter/controller is able to manage, in parallel, different types of sensors and selectively perform operations on the measured values. Multiple tasks can be performed in parallel; from a simple measurement, to a standard output signal, to the assignment of mathematical formulas for selectable values for controlling and dosing. The signal and function modules can be easily connected to each other by configuration. Thanks to individual parameterization, all functions can be adapted to the actual process conditions.

The basic unit is either a panel-mounted version or a wall-mounted version. It has analogue and digital outputs, digital inputs and its front panel has a backlit graphic display. Depending on the application, up to 6 slots are available in which pH/Redox, conductivity, analog and digital output modules, additional analog and digital input boards, and industrial Ethernet modules can be installed. There is no need for a separate 4...20 mA transmitter: the pH, conductivity modules accept raw signals from sensors.

Though highly functional the multiCELL can be operated easily and intuitively. The base for this is the large graphical display and the dynamically assigned function keys. Clearly arranged menu and module structures allow for easy configuration and setup of parameters and offer a high transparency for the functions in use. Four user views can be configured. This allows the user to design a view himself displaying a value arrangement which he likes to see simultaneously and this can be available 4 times and independent from each other.

For data collection and storage e.g. of measurement values there is an optional data logger available which uses the memory card if inserted in the card slot. Uploading and restoring the complete database of the complete 8619, including the special parameter settings of the application and the updating firmware via the memory card is available as standard.

Fully integration into the automation system can be realized with the optional available Industrial Ethernet Module. The protocols Modbus TCP and PROFINET Conformance Class B and EtherNet/IP are fully supported. Thanks to generic configuration files, routing within the PLC can be easily done.

**Construction**

**The main module slot enables:**

- connection to the transmitter/controller power supply
- to power another device
- the use of 2 digital inputs (DI), 2 analogue (AO) and 2 digital (DO) outputs

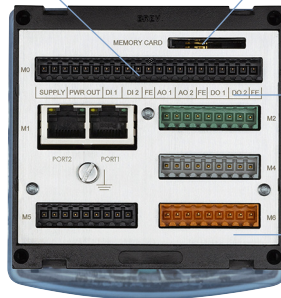

**Memory card slot:**

- For upload and download of parameter settings
  - Software updates and functional upgrades
- Simple operation: insert the memory card into the slot on the rear of the device.

**Additional module slots (up to 6) to choose among:**

- module for conductivity sensor and/or temperature sensor (green connector)
- module for pH/ORP sensor and/or temperature sensor (light grey connector)
- module for 2 analogue and 2 digital outputs (black connector)
- module for 2 analogue and 2 digital inputs (orange connector)
- module for Industrial Ethernet (2 RJ45 connectors)\*

**The main module slot enables:**

- the use of 2 digital inputs (DI), 2 analogue (AO) and 2 digital (DO) outputs

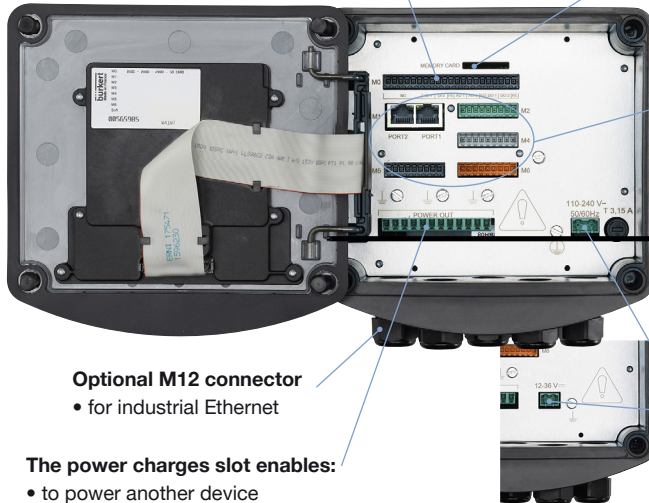

- Optional M12 connector**
- for industrial Ethernet

- The power charges slot enables:**
- to power another device

**Memory card slot:**

- For upload and download of parameter settings
  - Software updates and functional upgrades
- Simple operation: insert the memory card into the slot on the rear of the device.

**Additional module slots up to 6) to choose among:**

- module for conductivity sensor and/or temperature sensor (green connector)
- module for pH/ORP sensor and/or temperature sensor (light grey connector)
- module for 2 analogue and 2 digital outputs (black connector)
- module for 2 analogue and 2 digital inputs (orange connector)
- module for Industrial Ethernet (2 RJ45 connectors)\*

**The power supply slot enables:**

- connection to the transmitter/controller power supply (behind the protecting cover for 110...240 V AC version)

\* Ethernet module takes two slots  
The Ethernet module is available from Software version B.00.01

**Process diagram**

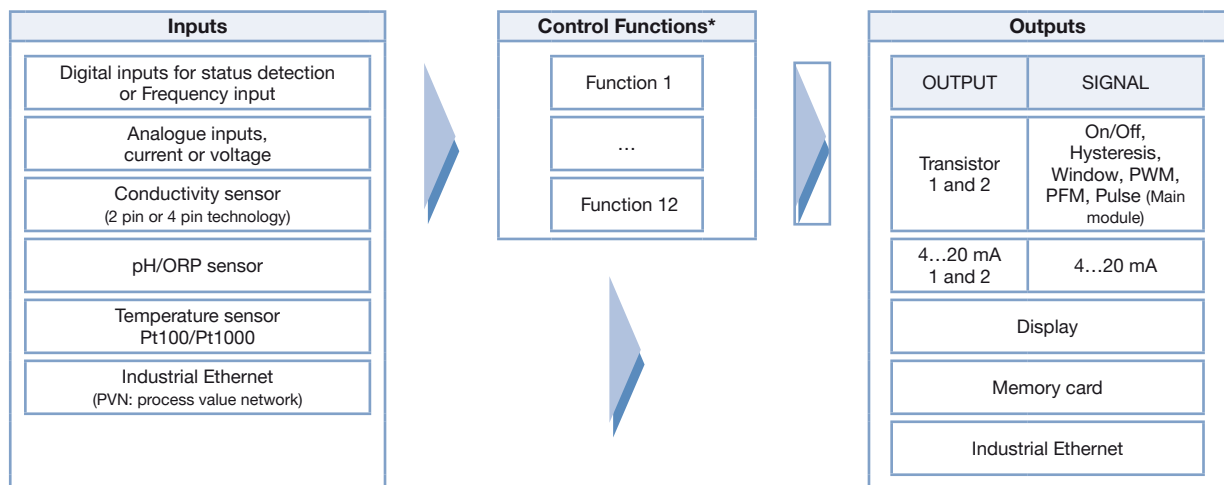

\* The 12 functions can be activated simultaneously and independently, and up to 6 PID functions can be set; if this option is selected.



## List of available functions

The transmitter/controller allows to allocate each sensor signal to a function fully configurable by the user (such as dosage, for example). According to the model the following functions are available as standard or as option

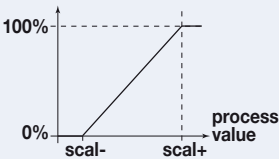
Functions	Availability	Formula	Example for usage
<b>Arithmetic</b>	Basic for all models	<b>A + B, A - B, A * B, A / B</b>	Arithmetic operation (addition, subtraction, multiplication and division) between 2 values. For addition and subtraction, the 2 values must have the same units, but for multiplication and division not necessarily. A and B can be constants, measured physical parameters, results of other active configured functions, the previous result of the same function, values sent by a PLC (PVN). The multiplication function is available from Software version B.00.01
<b>PASS</b>	Basic for all models	<b>A / B [%]</b>	A and B must have the same units and can be constants, measured physical parameters, results of other active configured functions, the previous result of the same function, values sent by a PLC (PVN) Calculates a flow ratio between 2 values. e.g: reverse osmosis
<b>REJECT</b>	Basic for all models	<b>(1 - A / B) [%]</b>	A and B must have the same units and can be constants, measured physical parameters, results of other active configured functions, the previous result of the same function, values sent by a PLC (PVN) Calculates a reject ratio between 2 values. e.g: reverse osmosis
<b>DEVIAT</b>	Basic for all models	<b>(A / B - 1) [%]</b>	Calculates a deviation ratio between 2 values.
<b>MATH</b>	As option	Permits to enter an equation which respects the following rules: <ul style="list-style-type: none"> <li>• up to 125 characters;</li> <li>• up to 5 process values (A, B, C, D &amp; E)</li> <li>• with possible operators: ( ) ! ± ^ × ÷ % + - &lt; &gt; ≤ ≥</li> </ul>	A, B, C, D, E can be constants, measured physical parameters, results of other active configured functions, the previous result of the same function, values sent by a PLC (PVN) e.g: (A*B)+(C*D)-E
<b>PROP</b>	Basic for all models		Calculates an output in proportion to a scaled input
<b>ON/OFF</b>	Basic for all models	<b>On/Off control loop</b>	For any type of input
<b>Flow rate measurement</b>	As base for model item no. 560 205, 560 213, 565 984, 565 985, 565 986, 565 987 for others as option		Allows both digital inputs to be used as frequency inputs for flow measurement (in standard for base unit) or coexistent with analytical modules (in option for others devices)
<b>PID</b>	As option	<b>Continuous control loop</b>	For any type of input and with internal or external setpoint
<b>Time dosing</b>	As option		e.g. for cooling tower application. Dosing of 1 or 2 biocides in the circuits, at fixed time intervals or by defining dosing during one week, with 2 dosings per day. Can be connected to an ON/OFF conductivity function for prebleed.
<b>Special Chemical batch (Volume dosing)</b>	As option		Specifically for cooling tower application. A defined volume of water is counted, then an actuator is energized during a defined time to add a chemical and the water volume being counted is resetted.
<b>Concentration</b>	As option		The concentration curves of NaCl, H <sub>2</sub> SO <sub>4</sub> , HNO <sub>3</sub> , NaOH, HCl are implemented for use in complete concentration range and not only in low concentration.
<b>Data logging on memory card</b>	As option		Up to 16 values can be stored at a defined time interval.

**Concentration tables multiCELL**

If multiCELL 8619 is equipped with a conductivity module, multiCELL is able to calculate the concentration depending on the measured conductivity and temperature. Therefore concentration tables for binary mixtures of (five) different substances and water are available. Determine the best suited concentration range (out of ten ranges) for your application.

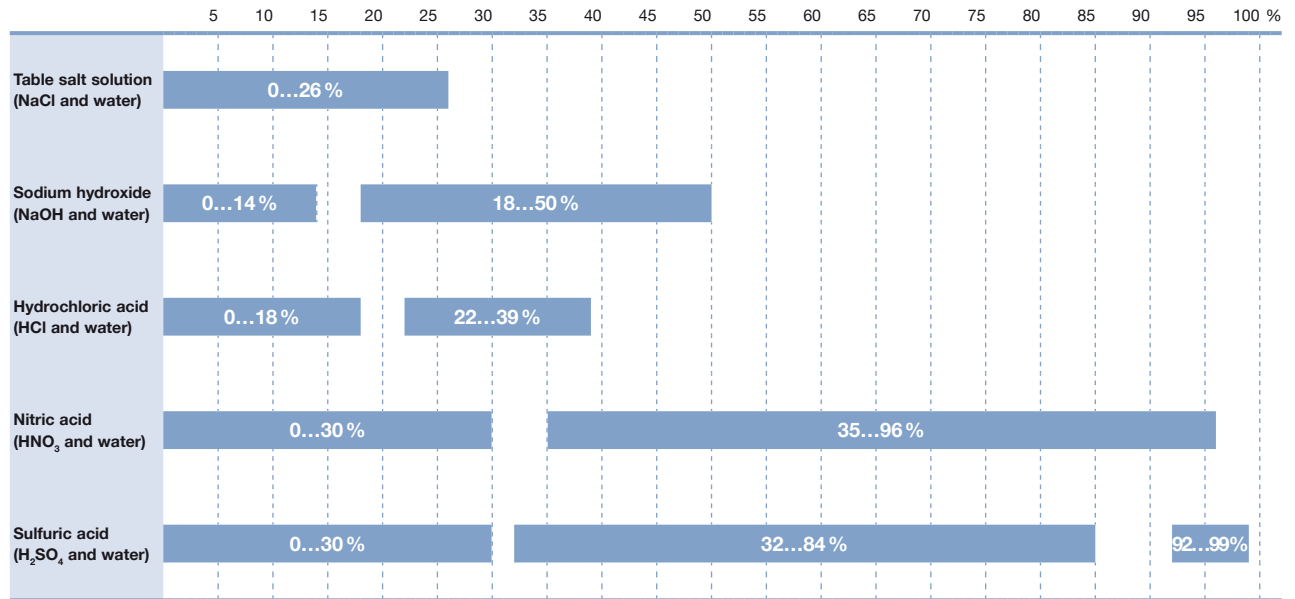

**Ordering chart for multiCELL transmitter/controller, Type 8619**

**Notes regarding the ordering of below mentioned multiCELL transmitter/controller:**

- The below items are equipped of arithmetic, PASS, REJECT, DEVIAT, MATH, PROP, ON/OFF functions in standard (see List of available functions, p. 9).  
In the BASE unit the Flow measurement function is also a standard function, the other functions are available as option.  
Please also use the "request for quotation" form on page 16 for ordering a device with additional options.
- If a totalizer function is required then a Flowmeter has to be connected via a digital input (main module or input module)

**Panel-mounted version, 12...36 V DC<sup>1)</sup>**

Description	Inputs			Outputs			UL <sup>2)</sup> certification	Article no.		
	Digital (DI) (On/Off or frequency)	Analogue (AI) 0/4...20 mA current and/or 0...2, 0...5, 0...10 V DC voltage	Number and type of sensor raw signals	Pt100/Pt1000	Transistor (DO) (PWM or PFM or On/Off or pulse)	Analogue (AO) 4...20 mA			Network protocol	
Base unit with flow measurement (Main module)	2	—	—	—	2	2	—	No	560205	
								Yes	560213	
Main module + 1 pH/ORP module	2	—	1 (pH/ORP)	1	2	2	—	No	560200	
								Yes	560208	
Main module + 2 pH/ORP modules + 1 output module	2	—	2 (pH/ORP)	2	4	4	—	No	560202	
								Yes	560210	
Main module + 1 conductivity module	2	—	1 (cond.)	1	2	2	—	No	560201	
								Yes	560209	
Main module + 2 conductivity modules + 1 output module	2	—	2 (cond.)	2	4	4	—	No	560203	
								Yes	560211	
Main module + 1 pH/ORP module + 1 conductivity module + 1 output module	2	—	1 (pH/ORP) + 1 (cond.)	2	4	4	—	No	560204	
								Yes	560212	
Main module + 1 input module	4	2	—	—	2	2	—	No	563960	
								Yes	563961	
Main module + 1 pH/ORP module + 1 input module + 1 output module	4	2	1 (pH/ORP)	1	4	4	—	No	563962	
								Yes	563963	
Main module + 1 conductivity module + 1 input module + 1 output module	4	2	1 (cond.)	1	4	4	—	No	563964	
								Yes	563912	
Main module + 1 Ethernet module	2	—	—	—	2	2	Modbus TCP <sup>3)</sup>	No	569259	
								PROFINET <sup>4)</sup>	No	569260
								EtherNet/IP <sup>4)</sup>	Yes	569261
Main module + 1 pH/ORP module + 1 Ethernet module	2	—	1 (pH/ORP)	1	2	2	Modbus TCP <sup>3)</sup>	No	569265	
								PROFINET <sup>4)</sup>	No	569266
								EtherNet/IP <sup>4)</sup>	Yes	569267
Main module + 1 conductivity module + 1 Ethernet module	2	—	1 (cond.)	1	2	2	Modbus TCP <sup>3)</sup>	No	569262	
								PROFINET <sup>4)</sup>	No	569263
								EtherNet/IP <sup>4)</sup>	Yes	569264

<sup>1)</sup> If the device is mounted in a humid environment or outside, then the maximum voltage allowed is **35 V DC** instead of 36 V DC.

<sup>2)</sup> UL-Listed (Measuring Equipment E237737).

<sup>3)</sup> If you order a device with a Modbus TCP network protocol, it does not include the other 2. If you would then like to change it with a PROFINET or EtherNet/IP network, the Ethernet protocol must be ordered (see Ordering chart for additional software functions, see page 14).

<sup>4)</sup> If you order a device with a PROFINET or EtherNet/IP network protocol, it also contains the other two.

**Ordering chart for multiCELL transmitter/controller, Type 8619**

**Wall-mounted version, 12...36 V DC<sup>1)</sup>**

Description	Inputs			Outputs			Network protocol	UL <sup>2)</sup> certification	Article no.
	Digital (DI) (On/Off or frequency)	Analogue (AI) 0/4...20 mA current and/or 0...2, 0...5, 0...10 V DC voltage	Number and type of sensor raw signals	Pt100/Pt1000	Transistor (DO) (PWM or PFM or On/Off or pulse)	Analogue (AO) 4...20 mA			
Base unit with flow measurement (Main module)	2	—	—	—	2	2	—	No	565984
								Yes	565986
Main module + 1 pH/ORP module	2	—	1 (pH/ORP)	1	2	2	—	No	565988
								Yes	565990
Main module + 2 pH/ORP modules + 1 output module	2	—	2 (pH/ORP)	2	4	4	—	No	565992
								Yes	565994
Main module + 1 conductivity module	2	—	1 (cond.)	1	2	2	—	No	565996
								Yes	565998
Main module + 2 conductivity modules + 1 output module	2	—	2 (cond.)	2	4	4	—	No	566000
								Yes	566002
Main module + 1 pH/ORP module + 1 conductivity module + 1 output module	2	—	1 (pH/ORP) + 1 (cond.)	2	4	4	—	No	566004
								Yes	566006
Main module + 1 input module	4	2	—	—	2	2	—	No	566008
								Yes	566010
Main module + 1 pH/ORP module + 1 input module + 1 output module	4	2	1 (pH/ORP)	1	4	4	—	No	566012
								Yes	566014
Main module + 1 conductivity module + 1 input module + 1 output module	4	2	1 (cond.)	1	4	4	—	No	566016
								Yes	566018
Main module + 1 Ethernet module	2	—	—	—	2	2	Modbus TCP <sup>3)</sup>	No	569268
							PROFINET <sup>4)</sup>	No	569269
							EtherNet/IP <sup>4)</sup>	Yes	569270
Main module + 1 pH/ORP module + 1 Ethernet module	2	—	1 (pH/ORP)	1	2	2	Modbus TCP <sup>3)</sup>	No	569274
							PROFINET <sup>4)</sup>	No	569275
							EtherNet/IP <sup>4)</sup>	Yes	569276
Main module + 1 conductivity module + 1 Ethernet module	2	—	1 (cond.)	1	2	2	Modbus TCP <sup>3)</sup>	No	569271
							PROFINET <sup>4)</sup>	No	569272
							EtherNet/IP <sup>4)</sup>	Yes	569273

<sup>1)</sup>  If the device is mounted in a humid environment or outside, then the maximum voltage allowed is **35 V DC** instead of 36 V DC.

<sup>2)</sup>  UL-Listed (Measuring Equipment E237737).

<sup>3)</sup> If you order a device with a Modbus TCP network protocol, it does not include the other 2. If you would then like to change it with a PROFINET or EtherNet/IP network, the Ethernet protocol must be ordered (see Ordering chart for additional software functions, see page 14).

<sup>4)</sup> If you order a device with a PROFINET or EtherNet/IP network protocol, it also contains the other two.

**Ordering chart for multiCELL transmitter/controller, Type 8619**

**Wall-mounted version, 110...240 V AC**

Description	Inputs			Outputs			Network protocol	UL <sup>1)</sup> certification	Article no.
	Digital (DI) (On/Off or frequency)	Analogue (AI) 0/4...20 mA current and/or 0...2, 0...5, 0...10 V DC voltage	Number and type of sensor raw signals	Pt100/Pt1000	Transistor (DO) (PWM or PFM or On/Off or pulse)	Analogue (AO) 4...20 mA			
Base unit with flow measurement (Main module)	2	—	—	—	2	2	—	No	565985
								Yes	565987
Main module + 1 pH/ORP module	2	—	1 (pH/ORP)	1	2	2	—	No	565989
								Yes	565991
Main module + 2 pH/ORP modules + 1 output module	2	—	2 (pH/ORP)	2	4	4	—	No	565993
								Yes	565995
Main module + 1 conductivity module	2	—	1 (cond.)	1	2	2	—	No	565997
								Yes	565999
Main module + 2 conductivity modules + 1 output module	2	—	2 (cond.)	2	4	4	—	No	566001
								Yes	566003
Main module + 1 pH/ORP module + 1 conductivity module + 1 output module	2	—	1 (pH/ORP) + 1 (cond.)	2	4	4	—	No	566005
								Yes	566007
Main module + 1 input module	4	2	—	—	2	2	—	No	566009
								Yes	566011
Main module + 1 pH/ORP module + 1 input module + 1 output module	4	2	1 (pH/ORP)	1	4	4	—	No	566013
								Yes	566015
Main module + 1 conductivity module + 1 input module + 1 output module	4	2	1 (cond.)	1	4	4	—	No	566017
								Yes	566019
Main module + 1 Ethernet module	2	—	—	—	2	2	Modbus TCP <sup>2)</sup>	No	569277
							PROFINET <sup>3)</sup>	No	569278
							EtherNet/IP <sup>3)</sup>	Yes	569279
Main module + 1 pH/ORP module + 1 Ethernet module	2	—	1 (pH/ORP)	1	2	2	Modbus TCP <sup>2)</sup>	No	569283
							PROFINET <sup>3)</sup>	No	569284
							EtherNet/IP <sup>3)</sup>	Yes	569285
Main module + 1 conductivity module + 1 Ethernet module	2	—	1 (cond.)	1	2	2	Modbus TCP <sup>2)</sup>	No	569280
							PROFINET <sup>3)</sup>	No	569281
							EtherNet/IP <sup>3)</sup>	Yes	569282

<sup>1)</sup> UL-Listed (Measuring Equipment E237737).

<sup>2)</sup> If you order a device with a Modbus TCP network protocol, it does not include the other 2. If you would then like to change it with a PROFINET or EtherNet/IP network, the Ethernet protocol must be ordered (see Ordering chart for additional software functions, see page 14).

<sup>3)</sup> If you order a device with a PROFINET or EtherNet/IP network protocol, it also contains the other two.

## Ordering chart for additional software functions for Type 8619

Use the following order codes only in case you already own a 8619 and you like to add one or more functions to your device.



**Please don't forget to note down the Article no. and serial number (see the device label) of your multiCELL on your order.**

Software option	Remark	Article no.
PID control	—	561836
Data Logger	SD card is not included.	561837
Chemical dosing (e.g. cooling tower)	The "Dosing" option also activates the "Flow" option if it does not exist by default in the device.	561838
Flow measurement	Is already included in the base unit device (560205 and 560213)	561839
Concentration measurement of selected fluids	Requires at least one conductivity hardware module	561840
Protocols Ethernet: Modbus TCP, PROFINET, EtherNet/IP	Ethernet-Module takes 2 slots. (Available only from Software version B.00.01; Already included in the device with a PROFINET or EtherNet/IP network protocol)	569286
MATH function	—	569848

Remark: the function upload and download of the complete data set of the 8619 is available as standard and does not need the data logger option

## Ordering chart for accessories for Type 8619

Description	Article no.
SDHC Memory Card - Class 10, 8 GB	564072
Mounting set for pipe mounting	564596
 Adapter for cable glands M20 x 1.5 with interface connector RJ45-M12 code D	569242

**Examples for interconnection possibilities with other Bürkert devices**

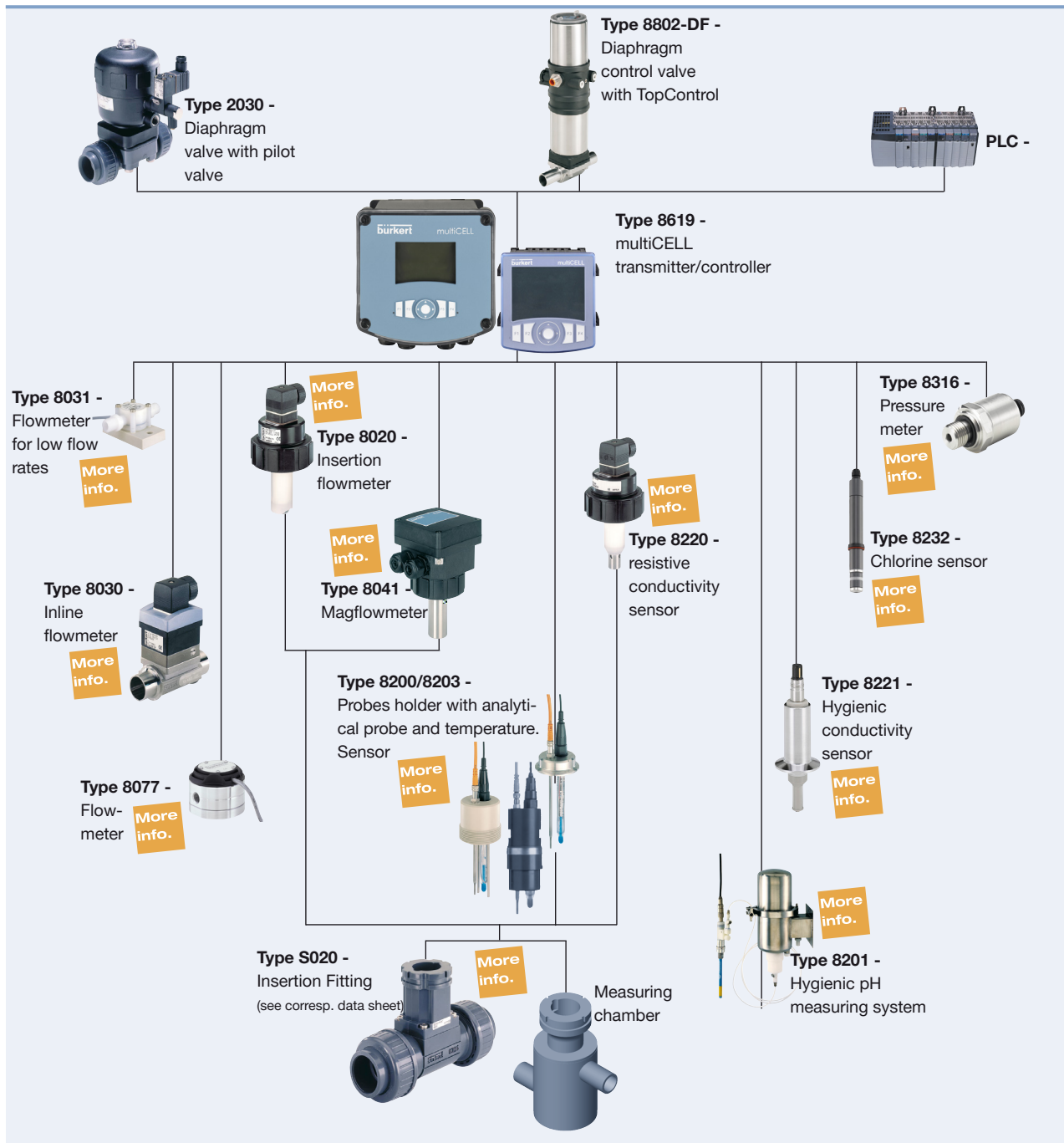

When you click on the orange box "More info." below, you will come to our website for the resp. product where you can download the data sheet.

**!** You will find more info about sensor-multiCELL connection cable in the data sheet of the selected sensor type. Please consult the corresponding data sheet.

**multiCELL Transmitter/controller, Type 8619 - request for quotation**

**Note**  
You can fill out the fields directly in the PDF file before printing out the form.

Please fill out this form and send to your local Bürkert Sales Centre\* with your inquiry or order

Company	Contact person
Customer no.	Dept.
Address	Tel./Fax
Town / Postcode	E-Mail

**8619 multiCELL transmitter/controller**

Quantity  Desired delivery date

**Models**

Panel-mounted version, 12...36 V DC  
 Wall-mounted version, 12...36 V DC  
 Wall-mounted version, 110...240 V AC

**Hardware**

Main module<sup>1)</sup> (without flow function; if needed please order the flow measurement software option)

	Slot					
	M1	M2	M3	M4	M5	M6
Ethernet module (takes up M1 and M3 slots)	<input type="checkbox"/>					
Conductivity + temperature module	<input type="checkbox"/>	<input type="checkbox"/>	<input type="checkbox"/>	<input type="checkbox"/>	<input type="checkbox"/>	<input type="checkbox"/>
pH/ORP + temperature module	<input type="checkbox"/>	<input type="checkbox"/>	<input type="checkbox"/>	<input type="checkbox"/>	<input type="checkbox"/>	<input type="checkbox"/>
Output module <sup>2)</sup>	<input type="checkbox"/>	<input type="checkbox"/>	<input type="checkbox"/>	<input type="checkbox"/>	<input type="checkbox"/>	<input type="checkbox"/>
Input module <sup>3)</sup>	<input type="checkbox"/>	<input type="checkbox"/>	<input type="checkbox"/>	<input type="checkbox"/>	<input type="checkbox"/>	<input type="checkbox"/>

<sup>1)</sup> 2 digital inputs + 2 analogue outputs + 2 transistor outputs  
<sup>2)</sup> 2 analogue outputs + 2 transistor outputs  
<sup>3)</sup> 2 analogue inputs + 2 digital inputs

**Software**

PID  
 Data logger  
 Chemical dosing\* (e.g. Cooling Tower) + special batch  
 Flow measurement  
 Concentration Measurement for selected fluids  
(only if one of the slot is equipped with a conductivity module)  
 MATH function

\* The "Dosing" option also activates the "Flow" option if it does not exist by default in the device

**Ethernet protocols**

Modbus TCP  
 PROFINET  
 EtherNet/IP

**UL certification**

Yes  
 No

NOTE: If a totalizer function is required then a flowmeter has to be connected via a digital input (Main module or input module)

DTS 1000130448 EN Version: P Status: RL (released | freigegeben | valide) printed: 05.04.2018

\*To find your nearest Bürkert facility, click on the orange box →

[www.burkert.com](http://www.burkert.com)

In case of special application conditions, please consult for advice.

Subject to alteration.  
© Christian Bürkert GmbH & Co. KG

1804/15\_EU-en\_00895144