



## Pneumatically operated 2/2 way diaphragm valve CLASSIC with plastic body

- Flow optimised and deadleg free bodies
- Hermetical separation of fluids from the operating mechanism by diaphragm
- Robust actuators with modular accessory program
- Self-draining plastic bodies with true union, solvent socket, weld ends or flanges
- Applicable for aggressive and corrosive media

For process valves with decentralized automation see ELEMENT Type 2103

Type 2030 can be combined with...



**Type 8697**  
Pneumatic control unit



**Type 3232**  
Manual diaphragm Valve



**Type 6012**  
Plunger valve

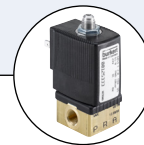

**Type 6014**  
Plunger valve

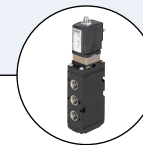

**Type 6519**  
Servo-assisted solenoid valve

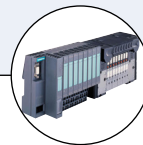

**Type 8644**  
AirLINE system

Pilot controlled diaphragm valve with piston actuator and diaphragm seal. As standard, actuator from PA. The flow optimised and zero dead volume valve body makes high flow rates possible.

### Installation for self-draining

$\alpha = 15^\circ$  up to  $30^\circ$  plus  $3^\circ$  up to  $5^\circ$  inclination to pipe axis

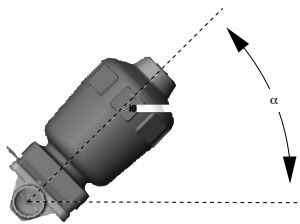

### Technical data

<b>Orifice</b> (diaphragm size)	DN15...100
<b>Body materials</b>	PVC-U, PP, PVDF
<b>Actuator material</b>	PA polyamide (PPS on request)
<b>Seal material</b>	EPDM, PTFE/EPDM
<b>Media</b>	Neutral gases and liquids, aggressive or abrasive media
<b>Viscosity</b>	Up to viscous
<b>Media temperature</b>	See charts p. 2
<b>Ambient temperature</b>	- 10 to +60 °C (PA) Actuator size $\geq 175$ mm: - 10 to +50 °C
<b>Control medium</b>	Neutral gases, air
<b>Port connections</b>	DN15...50: True union and spigot connections DN65: Loose flanges DN80...100: Fixed flanges
<b>Installation</b>	As required, preferably with actuator in upright position

Media temperature

Pressure-temperature compatibility charts

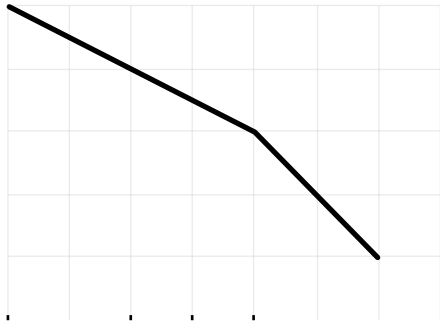

Materials DN65...100

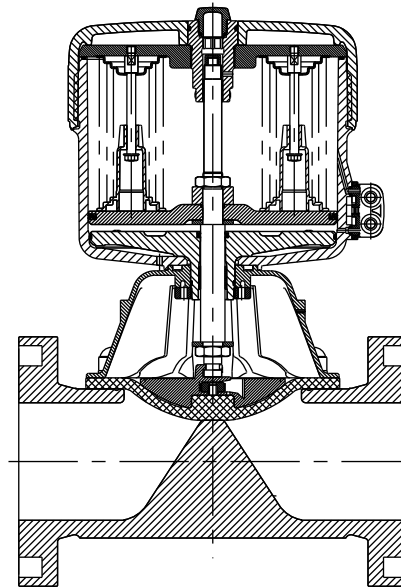
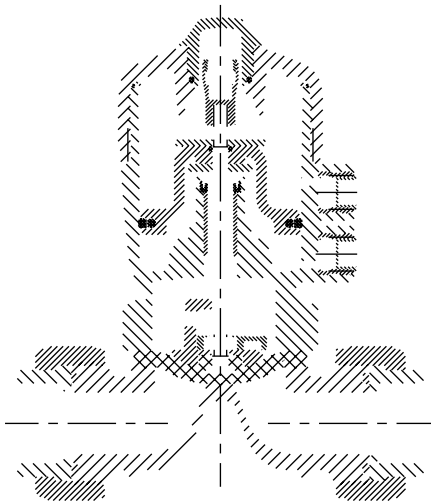

## Ordering chart for diaphragm valves with piston actuator (other versions on request)

Body in PVC-U with true union or spigot connections  
DN15...50

Control function	Port connection [mm]	Orifice Diaphragm size [mm]	Actuator size Ø [mm]	K <sub>v</sub> value water [m <sup>3</sup> /h]	Minimum pilot pressure [bar]	Operating pressure [bar]	Article no. true union	
<b>Seal material EPDM</b>								
<b>A</b>  2/2 way, NC by spring action	20	15	50	3.0	5.0	8.5	317273	
			63	3.5	5.0	10	317274	
	25	20	63	7.0	5.5	10	317276	
				8.0	5.5	10	317277	
				10.0	5.5	10	317278	
				18.0	5.5	6.5	317279	
				24.0	5.5	10	317280	
26.0	5.5	10	317281					
<b>B</b>  2/2 way, NO by spring action	20	15	50	3.0	see chart 1 on p. 5	10	317275	
			63	7.0		10	317282	
	25	20	63	8.0	11.0	see chart 2 on p. 5	10	317284
				10.0	18.0		10	317285
				18.0	24.0	10	317286	
				24.0	43.0	10	317287	
				43.0	43.0	10	317287	
<b>Seal material PTFE/EPDM</b>								
<b>A</b>  2/2 way, NC by spring action	20	15	50	3.0	5.0	5	262237	
			63	3.5	5.0	10	262245	
	25	20	63	7.0	5.5	5	262760	
				8.0	5.0	10	262742	
				11.0	5.5	7.5	262744	
				18.0	5.5	8	262746	
				24.0	5.5	6.0	262761	
26.0	5.5	10	262749					
43.0	5.5	7	262751					
<b>B</b>  2/2 way, NO by spring action	20	15	63	3.5	see chart 3 on p. 5	10	262306	
			80	7.0		10	262753	
	25	20	80	11.0	11.0	see chart 4 on p. 5	10	262755
				18.0	18.0		10	on request
				26.0	26.0	10	262758	
				43.0	43.0	10	274572	
				43.0	43.0	10	274572	

## Further versions on request

**Materials**

Actuator: PPS

**Control function**

I Double-acting actuator

**Port connection**

Spigot

## Ordering chart for diaphragm valves with piston actuator (other versions on request)

Body in PP with true union or spigot connections  
DN15...50

Control function	Port connection [mm]	Orifice Diaphragm size [mm]	Actuator size Ø [mm]	K <sub>v</sub> value water [m <sup>3</sup> /h]	Minimum pilot pressure [bar]	Operating pressure [bar]	Article no. true union	Article no. spigot		
<b>Seal material EPDM</b>										
<b>A</b>  2/2 way, NC by spring action	20	15	50	3.0	5.0	8.5	317258	317235		
			63	3.5	5.0	10	317259	317237		
	25	20	63	7.0	5.5	10	317260	317250		
			32	25	80	11.0	5.5	10	317261	317238
			40	32	100	18.0	5.5	10	317262	317240
			50	40	100	24.0	5.5	6.5	317263	317241
			125	26.0	5.5	10	317265	317242		
63	50	125	43.0	5.5	8	317266	317243			
<b>B</b>  2/2 way, NO by spring action	20	15	50	3.0	see chart 1 on p. 5	10	317267	317244		
			63	7.0	10	317268	317245			
	25	20	63	11.0	10	317269	317251			
			32	25	80	18.0	10	317270	317246	
			40	32	100	24.0	10	317271	317247	
			50	40	100	43.0	10	317272	317249	
			125	26.0	10	317272	317249			
63	50	125	43.0	10	317272	317249				
<b>Seal material PTFE/EPDM</b>										
<b>A</b>  2/2 way, NC by spring action	20	15	50	3.0	5.0	5	154770	144295		
			63	3.5	5.0	10	154781	141454		
	25	20	63	7.0	5.5	5	154784	144299		
			80	7.0	5.0	10	154785	141464		
			32	25	80	11.0	5.5	7.5	154787	141471
			40	32	100	18.0	5.5	8	154789	141477
			50	40	100	24.0	5.5	6.0	154792	144303
125	26.0	5.5	10	154793	141486					
63	50	125	43.0	5.5	7	154795	141492			
<b>B</b>  2/2 way, NO by spring action	20	15	63	3.5	see chart 3 on p. 5	10	154807	141502		
			80	7.0	10	154810	141513			
	25	20	80	11.0	10	154812	141520			
			32	25	80	18.0	10	154814	141526	
			40	32	100	26.0	10	154817	141535	
			50	40	125	43.0	10	154819	141541	
			125	26.0	10	154819	141541			
63	50	125	43.0	10	154819	141541				

## Further versions on request

**Materials**











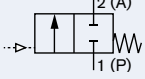















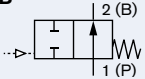

Actuator: PPS

**Control function**

I Double-acting actuator

## Ordering chart for diaphragm valves with piston actuator (other versions on request)

Body in PVDF with true union or spigot connections  
DN15...50

Control function	Port connection [mm]	Orifice Diaphragm size [mm]	Actuator size Ø [mm]	K <sub>v</sub> value water [m <sup>3</sup> /h]	Minimum pilot pressure [bar]	Operating pressure [bar]	Article no. true union	Article no. spigot		
<b>Seal material PTFE/EPDM</b>										
<b>A</b>  2/2 way, NC by spring action	20	15	50	3.0	5.0	5	154796 	144296 		
			63	3.5	5.0	10	154797 	141453 		
	25	20	63	7.0	5.5	5	154798 	144300 		
			80	7.0	5.0	10	154799 	141463 		
			32	25	80	11.0	5.5	7.5	154800 	141470 
			40	32	100	18.0	5.5	8	154801 	141476 
			50	40	100	24.0	5.5	6.0	154802 	144337 
63	50	125	26.0	5.5	10	154803 	141485 			
<b>B</b>  2/2 way, NO by spring action	20	15	63	3.5	see chart 3 underneath	10	154820 	141501 		
	25	20	80	7.0		10	154821 	141512 		
	32	25	80	11.0		10	154822 	141519 		
	40	32	100	18.0	see chart 4 underneath	10	154823 	141525 		
	50	40	125	24.0		10	154824 	141534 		
	63	50	125	43.0		10	154825 	141540 		

 Further versions on request

## Materials











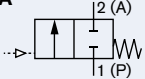

Actuator: PPS

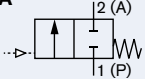

## Control function

I Double-acting actuator

Body in PVC-U with flange connection  
DN65...100

Control function	Port connection	Orifice Diaphragm size [mm]	Actuator size Ø [mm]	K <sub>v</sub> value water [m <sup>3</sup> /h]	Minimum pilot pressure [bar]	Operating pressure [bar]	Article no. flanges
<b>Seal material EPDM</b>							
<b>A</b>  2/2 way, NC by spring action	Loose flanges	65	125	55.0	5.5	7	317257 
			175	60	4.5	8	317252 
	Fixed flanges	80	175	100	5.0	5	317253 
			225	100	5.0	10	317254 
Fixed flanges	100	225	160	5.0	8	317255 	
<b>Seal material PTFE/EPDM</b>							
<b>A</b>  2/2 way, NC by spring action	Loose flanges	65	125	55	5.5	4.5	149296 
			175	60	4.5	5	147845 
	Fixed flanges	80	175	100	5.0	4.5	147847 
			225	100	5.0	10	147849 
Fixed flanges	100	225	160	5.0	4	147850 	

Pilot pressure charts for control function B

Seal material EPDM

Chart 1 – orifice 15...25

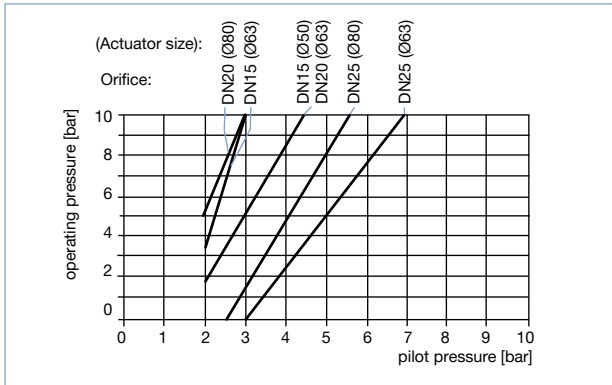
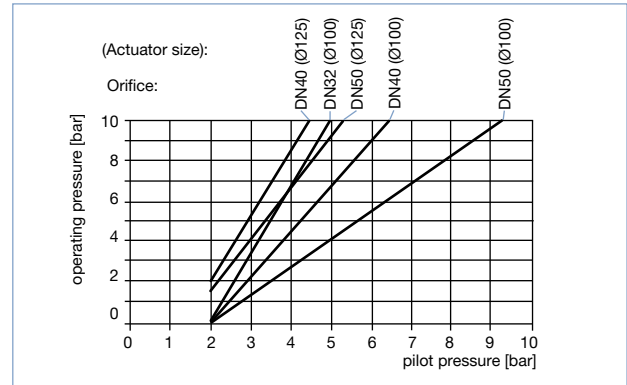

Chart 2 – orifice 32...50



Seal material PTFE/EPDM (EA)

Chart 3 – orifice 15...25

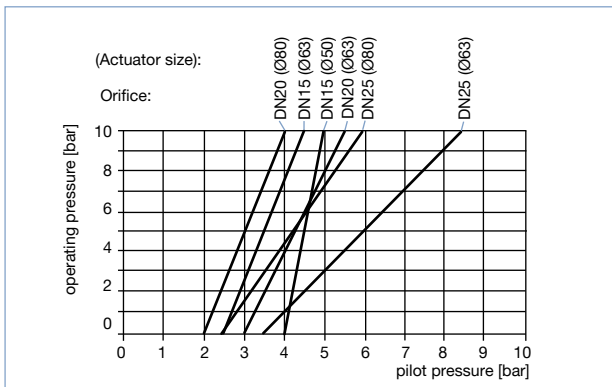
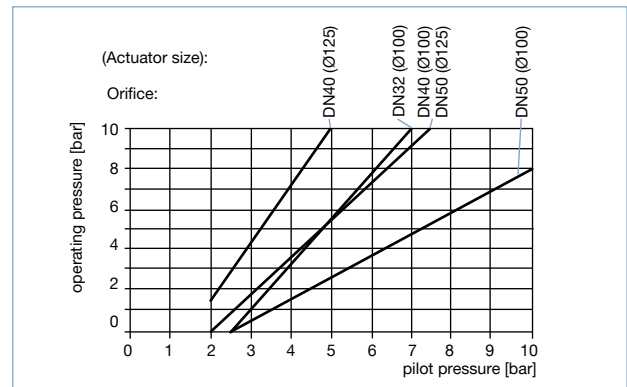

Chart 4 – orifice 32...50



Ordering chart for accessories

3/2 way pilot valves with banjo bolts

Seal material valve FKM, seal material banjo bolt NBR

Valve for actuator size [Ø mm]	Type	Pressure inlet P (valve body)	Service port A (banjo bolt)	Orifice [mm]	Q <sub>ln</sub> value air [l/min]	Pressure range [bar]	Electrical coil connection Ind. Std.	Power consumption [W]	Article no.	
									024/DC	230/50
50	6012P	G ¼	G ½	1.2	48	0...10	Form B	4	552295	552298
63	6012P	Tube fitting Ø6 mm	G ¼	1.2	48	0...10	Form B	4	552283	552286
63...125	6014P	G ¼	G ¼	2	120	0...10	Form A	8	424103	424107
175...225	6014P	G ½	G ¼	2.5	174	0...6	Form A	8	786014	786015
175...225	0331P	G ¼	G ¼	3	194	0...10	Form A	8	-	041233

Cable plug Type 2507, Form B or Type 2508, Form A

	Article no.
Type 2507, Form B Industrial standard, 0...250 V without circuitry (Type 6012 P)	423845
Type 2508, Form A acc. DIN EN 175 301 - 803, 0...250 V without circuitry (Type 6014 P, Type 0331P)	008376

For further accessories see the datasheet for Type 1062 or the accessories datasheet, Type 2XXX for the full options programme.

**Note:** For design reasons, some of the accessories cannot be supplied for actuator size Ø 40, 175 and 225 mm. Please request the accessories datasheet Type 2XXX.

Dimensions [mm]

DN15...50

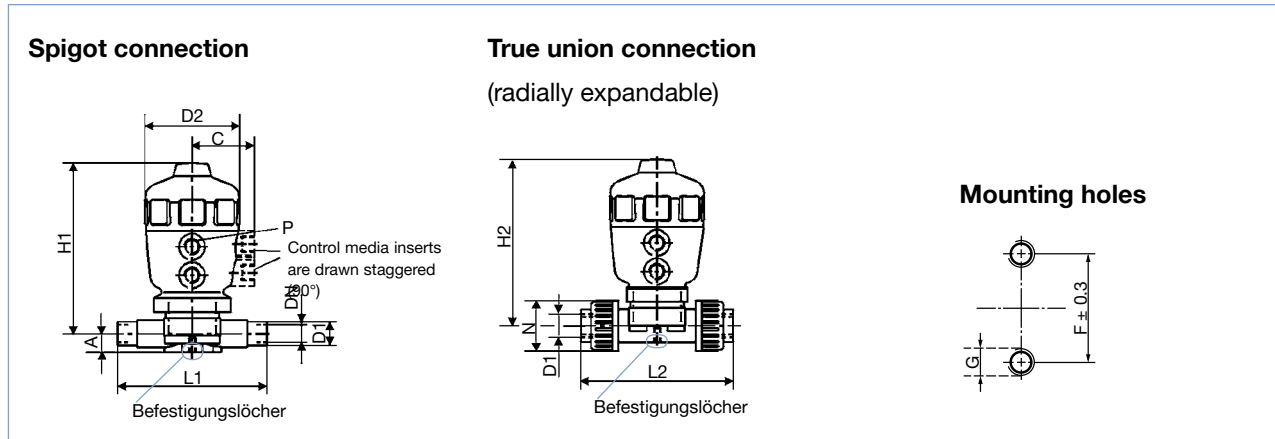

Orifice [mm] (diaphragm size)	All bodies							Spigot connection			True union connection		
	Actuator size Ø	C	D1	D2	P	F ± 0.3	G	A	H1	L1	L2	H2	N
15	50	39	20	64	G 1/8	25	M6	14	121	124	128	123	43
	63	52	20	80	G 1/4	25	M6	14	137	124	128	139	43
20	63	52	25	80	G 1/4	25	M6	18	146	144	152	148	53
	80	60	25	101	G 1/4	25	M6	18	172	144	152	173	53
25	80	60	32	101	G 1/4	25	M6	21	175	154	166	176	60
32	100	73	40	127	G 1/4	45	M8	26	229	174	192	231	74
40	100	73	50	127	G 1/4	45	M8	33	236	194	222	239	83
	125	86	50	153	G 1/4	45	M8	33	276	194	222	277	83
50	125	86	63	153	G 1/4	45	M8	39	283	224	266	284	103

DN65...100

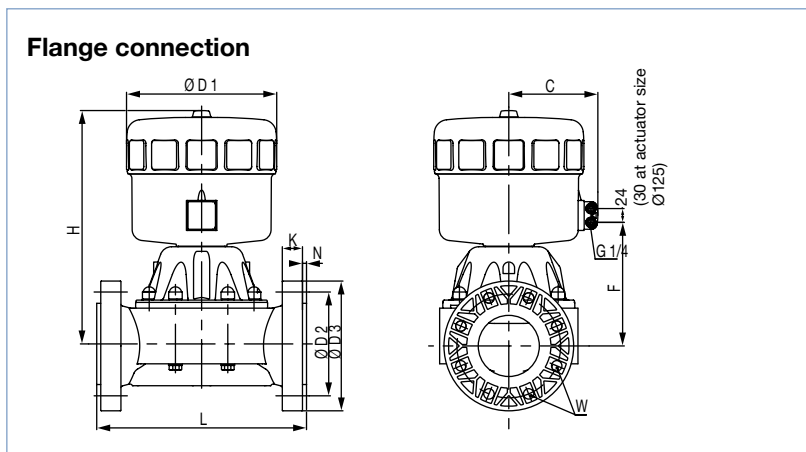

Orifice [mm] (diaphragm size)	Actuator size	Port connection	C	D1	D2	D3	F	H	K	L	W
65	125	Loose flanges	86	158	145	185	129	295	29	290	4 × 90°
	175	Loose flanges	130	211	145	185	180	387	29	290	4 × 90°
80	175	Fixed flanges	130	211	160	200	197	398	36	310	8 × 45°
	225	Fixed flanges	155	261	160	200	198	393	36	310	8 × 45°
100	225	Fixed flanges	155	261	180	225	210	410	36	350	8 × 45°

To find your nearest Bürkert facility, click on the orange box → [www.burkert.com](http://www.burkert.com)

In case of special application conditions, please consult for advice.

Subject to alteration.  
© Christian Bürkert GmbH & Co. KG

1712/16\_EU-en\_00891670